

CITY COUNCIL AGENDA

November 14, 2016

J-4 Standard Purchasing Resolutions:

a) Standard Purchasing Resolution 2: Low Bidder Meeting Specifications – Fitness Equipment

Resolution #2016-11-193-J-4a

RESOLVED, That Troy City Council hereby **AWARDS** three (3) contracts to the low bidders meeting specifications to provide fitness equipment for the Troy Community Center to *Forte Fitness of Ida, MI* for \$9,190.00, *All Pro Exercise of Plymouth Township, MI*, for \$46,740.00 and *Direct Fitness Solutions, LLC of Mundelein, IL*, for \$9,180.00 as detailed below for an estimated total cost (less one to one trade ins) of \$65,110.00 all at prices contained in the bid tabulation dated October 20, 2016, a copy of which shall be **ATTACHED** to the original Minutes of this meeting.

	Forte Fitness, Inc.	All Pro Exercise	Direct Fitness Solutions, LLC
TOTAL COST FOR NEW EQUIPMENT	\$9,990.00	\$54,340.00	\$9,980.00
Deduct Trade-Ins	\$800.00	\$7,600.00	\$800.00
Estimated Grand Total Cost bid as specified less Trade-in Items:	\$9,190.00	\$46,740.00	\$9,180.00
Estimated Grand Total Cost:	\$65,110.00		

BE IT FURTHER RESOLVED, That the award is **CONTINGENT** upon the company's submission of properly executed bid and contract documents, including insurance certificates and all other specified requirements.

Bid Checklist

BASIC INFORMATION

Requisition Number: 2017-1...137
Bid Name: Fitness Equipment
Bid Number: ITB-COT 16-35
Originating Department: Comm. Center
Bid Opening Date: 10.20.2016

CHECKLIST

DATE // ADDITIONAL NOTES:

- Bid documents to department for review
- Bid documents approved by department
- Bid documents finalized
- Bid posted to MITN 10.5.2016
- Bid notice posted at City Clerk's Office
- Bid opening scheduled on Outlook
If necessary, pre-bid meeting scheduled to Outlook
- Bid tab created
- Addendums

Date posted:

Completed by:

Date:

- Bid tabulation complete
- Bid tabulation reviewed
- Checked vendor debarment list
- Bid tabulation to department for review
- Memo/Resolution to Purchasing
- Memo/Resolution to City Manager
- City Council Agenda date
- Notice of Award emailed
- Bid deposit checks returned

11.14.2016

Bid award posted to MITN

- Insurance reviewed
- Bonds reviewed
- Purchase Order #

Date entered:

Date mailed:

Contract needed: circle: Yes or No

To clerk for signatures:

Performance measures

Documents scanned

Notes Insurance:

Additional comments:



PURCHASE ORDER

Ship To

CITY OF TROY
Parks and Recreation
3179 LIVERNOIS
TROY, MI 48083

Bill To

CITY OF TROY
Parks and Recreation
3179 LIVERNOIS
TROY, MI 48083

No. 2017-00000432
DATE: 11/16/2016
PAGE: 1 of 1
FOB DESTINATION

VENDOR NO. 133436

COUNCIL RESOLUTION
2016-11-193-J-4a

Vendor

ALL-PRO EXERCISE INC
45255 FIVE MILE RD
PLYMOUTH, MI 48170

COPY

QUANTITY	UNIT	DESCRIPTION	UNIT COST	TOTAL COST
1	Lot	Fitness Equipment for Community Center Fitness Room Fitness equipment less trade-ins. Fitness equipment to be furnished and installed in the Troy Community Center Fitness Room. All items to be furnished in accordance with all bid specifications as per ITB-COT 16-35 and your accepted proposal. Itemized pricing and trade-in information is attached to this purchase order.	43,045.0000	\$43,045.00
Entered By: MaryBeth Murz				\$43,045.00

Special Instructions:
 Deliver as per Bid Specifications in accordance with ITB-COT 16-35. Contact Brian Goul, Assistant Recreation Director at 248 524 3529 prior to delivery. City Council approval date: 11/14/2016. Acceptable insurance certificate required to be on file prior to delivery and installation of equipment.

TERMS & CONDITIONS

1. Purchases of Municipalities are exempt from State Sales and Federal Excise Taxes.
2. Prior to acceptance, vendor agrees to provide City with information under the Right-to-Know Law, P.A. 1986, No. 80, and fully comply with all terms and conditions of the Michigan Occupational Safety and Health Act, MCL 408.1001, et seq. including vendor shall provide City with an "MSDS". Vendor also agrees to be responsible for all required labeling.
3. In cases of emergency/disaster, the City can purchase up to six(6) times the order amount for a period of six(6) months at the price contained in the contract.
4. Purchase Orders are signed electronically based upon computer generated "on-line" authorized approvals. Authentic signatures are on file in the City of Troy Purchasing Department.

NOTICE: The City could put the vendor on notice that vendors will be held financially responsible for any claims or awards made against the City as a result of the vendor's action. If the City has to defend the initial lawsuit, the City will bring in the vendor as a co-defendant or sue the vendor, either as the result of settling a claim or the conclusion of the lawsuit.

HEREBY CERTIFY THAT THIS ORDER IS PROPERLY AUTHORIZED AND APPROVED.

MaryBeth Murz

CITY OF TROY
PURCHASE ORDER
PHYSICAL FITNESS EQUIPMENT

ITB-COT 16-35
Page 1 of 2

ALL PRO EXERCISE
Plymouth, MI

PHYSICAL FITNESS EQUIPMENT IN THE TROY COMMUNITY CENTER FITNESS ROOM IN ACCORDANCE WITH THE ATTACHED SPECIFICATIONS AS FOLLOWS:

EQUIPMENT TO PURCHASE (Not for trade-in exchange)				
ITEM	QTY	Description (No Substitutions)	Unit Cost (Each)	Estimated Total Cost
4	6	Matrix #T5x-2016, heavy commercial Treadmill	\$4,795.00	\$28,770.00
5	3	Matrix A3x heavy commercial Ascent Trainer	\$4,895.00	\$14,685.00
6	2	Matrix E3x heavy commercial Elliptical	\$3,595.00	\$7,190.00
7	1	Octane XR6000 X Ride Seated Total Body Elliptical	\$3,695.00	\$3,695.00
TOTAL COST FOR NEW EQUIPMENT				\$50,645.00
8 TRADE-INS				
	QTY	Description	Estimated Trade-In Amount (Each)	Estimated Trade-In Amount Total
4	6	Matrix #T5x- 2013 Treadmills	\$700.00	\$4,200.00
5	3	Matrix A3x Ascent Trainers- 2013	\$600.00	\$1,800.00
6	2	Matrix E3x Elliptical- 2013	\$500.00	\$1,000.00
7	1	Octane XR6000 Xride- 2012	\$600.00	\$600.00
DEDUCT:				\$7,600.00
Estimated Net Total Cost (All Items #4-7 Less All				\$43,045.00

PURCHASE ORDER

Ship To
 CITY OF TROY
 Parks and Recreation
 3179 LIVERNOIS
 TROY, MI 48083

Bill To
 CITY OF TROY
 Parks and Recreation
 3179 LIVERNOIS
 TROY, MI 48083

No. 2017-00000425
 DATE: 11/16/2016
 PAGE: 1 of 1
 FOB DESTINATION

VENDOR NO. 162014

COPY

COUNCIL RESOLUTION
 2016-11-193-J-4a

Vendor
 DIRECT FITNESS SOLUTIONS
 600 TOWER ROAD
 MUNDELEIN, IL 60060

QUANTITY	UNIT	DESCRIPTION	UNIT COST	TOTAL COST
1	Lot	Fitness Equipment for Community Center Fitness Room Fitness equipment less trade-ins. Fitness equipment to be furnished and installed in the Troy Community Center Fitness Room. All items to be furnished in accordance with all bid specifications as per ITB-COT 16-35 and your accepted proposal. Itemized pricing and trade-in information is attached to this purchase order.	9,180.0000	\$9,180.00
				\$9,180.00

Special Instructions: Entered By: MaryBeth Murz
 Deliver as per Bid Specifications in accordance with ITB-COT 16-35. Contact Brian Goul, Assistant Recreation Director at 248 524 3529 prior to delivery. City Council approval date: 11/14/2016. Acceptable insurance certificate required to be on file prior to delivery and installation of equipment.

TERMS & CONDITIONS

1. Purchases of Municipalities are exempt from State Sales and Federal Excise Taxes.
2. Prior to acceptance, vendor agrees to provide City with information under the Right-to-Know Law, P.A. 1986, No. 80, and fully comply with all terms and conditions of the Michigan Occupational Safety and Health Act, MCL 408.1001, et seq. including vendor shall provide City with an "MSDS". Vendor also agrees to be responsible for all required labeling.
3. In cases of emergency/disaster, the City can purchase up to six(6) times the order amount for a period of six(6) months at the price contained in the contract.
4. Purchase Orders are signed electronically based upon computer generated "on-line" authorized approvals. Authentic signatures are on file in the City of Troy Purchasing Department.

NOTE: The City could put the vendor on notice that vendors will be held financially responsible for any claims or awards made against the City as a result of the vendor's action. If the City has to defend the initial lawsuit, the City will bring in the vendor as a co-defendant or sue the vendor, either as the result of settling a claim or the conclusion of the lawsuit.

REBY CERTIFY THAT THIS ORDER IS PROPERLY AUTHORIZED AND APPROVED.

MaryBeth Murz



CITY OF TROY
PURCHASE ORDER
PHYSICAL FITNESS EQUIPMENT

ITB-COT 16-35
Page 1 of 2

DIRECT FITNESS SOLUTIONS, LLC
Mundelein, IL

FITNESS EQUIPMENT IN THE TROY COMMUNITY CENTER FITNESS ROOM IN ACCORDANCE WITH THE ATTACHED SPECIFICATIONS AS FOLLOWS:

EQUIPMENT TO PURCHASE (1 FOR 1 trade-in exchange)

ITEM	QTY	Description (No Substitutions)	Unit Cost (Each)	Estimated Total Cost
1	2	PreCor Vitality Multi-Press CO24ES	\$2,495.00	\$4,990.00
2	2	PreCor Vitality Leg Extension/ Leg Curl CO27ES	\$2,495.00	\$4,990.00
TOTAL COST FOR NEW EQUIPMENT				\$9,980.00
TRADE-INS				
	QTY	Description	Estimated Trade-In Amount (Each)	Estimated Trade-In Amount Total
1	1	Lifefitness Hammer Strength Shoulder Press- 2002	\$200.00	\$200.00
2	1	Lifefitness Hammer Strength incline Press- 2002	\$200.00	\$200.00
3	1	Lifefitness Hammer Leg Curl- 2002	\$200.00	\$200.00
4	1	Lifefitness Hammer Strength Leg Extension- 2002	\$200.00	\$200.00
		DEDUCT:		\$800.00
Estimated Net Total Cost (All Items 1 & 2 less All				\$9,180.00



PURCHASE ORDER

Ship To

CITY OF TROY
Parks and Recreation
3179 LIVERNOIS
TROY, MI 48083

Bill To

CITY OF TROY
Parks and Recreation
3179 LIVERNOIS
TROY, MI 48083

No. 2017-00000433
DATE: 11/16/2016
PAGE: 1 of 1
FOB DESTINATION

VENDOR NO. 171613

COUNCIL RESOLUTION
2016-11-193-J-4a

Vendor

FORTE FITNESS INC.
7965 IDA CENTER RD
IDA, MI 48140

COPY

QUANTITY	UNIT	DESCRIPTION	UNIT COST	TOTAL COST
1	Lot	Fitness Equipment for Community Center Fitness Room Fitness equipment less trade-ins. Fitness equipment to be furnished and installed in the Troy Community Center Fitness Room. All items to be furnished in accordance with all bid specifications as per ITB-COT 16-35 and your accepted proposal. Itemized pricing and trade-in information is attached to this purchase order.	9,190.0000	\$9,190.00
				\$9,190.00

Entered By: MaryBeth Murz

Special Instructions:

Deliver as per Bid Specifications in accordance with ITB-COT 16-35. Contact Brian Goul, Assistant Recreation Director at 248 524 3529 prior to delivery. City Council approval date: 11/14/2016. Acceptable insurance certificate required to be on file prior to delivery and installation of equipment.

TERMS & CONDITIONS

1. Purchases of Municipalities are exempt from State Sales and Federal Excise Taxes.
 2. Prior to acceptance, vendor agrees to provide City with information under the Right-to-Know Law, P.A. 1986, No. 80, and fully comply with all terms and conditions of the Michigan Occupational Safety and Health Act, MCL 408.1001, et seq. including vendor shall provide City with an "MSDS". Vendor also agrees to be responsible for all required labeling.
 3. In cases of emergency/disaster, the City can purchase up to six(6) times the order amount for a period of six(6) months at the price contained in the contract.
 4. Purchase Orders are signed electronically based upon computer generated "on-line" authorized approvals. Authentic signatures are on file in the City of Troy Purchasing Department.
- NOTICE: The City could put the vendor on notice that vendors will be held financially responsible for any claims or awards made against the City as a result of the vendor's action. If the City has to defend the initial lawsuit, the City will bring in the vendor as a co-defendant or sue the vendor, either as the result of settling a claim or the conclusion of the lawsuit.

REBY CERTIFY THAT THIS ORDER IS PROPERLY AUTHORIZED AND APPROVED.

MaryBeth Murz



CITY OF TROY
PURCHASE ORDER
PHYSICAL FITNESS EQUIPMENT

ITB-COT 16-35
Page 1 of 2

FORTE FITNESS, INC.
Ida, MI

PHYSICAL FITNESS EQUIPMENT IN THE TROY COMMUNITY CENTER FITNESS ROOM IN ACCORDANCE WITH THE ATTACHED SPECIFICATIONS AS FOLLOWS:

EQUIPMENT TO PURCHASE (1 for 1 trade-in exchange)

ITEM	QTY	Description (No Substitutions)	Unit Cost (Each)	Estimated Total Cost
3	2	FreeMotion i11.9 Incline Treadmill	\$4,995.00	\$9,990.00
TOTAL COST FOR NEW EQUIPMENT				\$9,990.00
8	TRADE-INS			
	QTY	Description	Estimated Trade-In Amount (Each)	Estimated Trade-In Amount Total
	2	Matrix #T5x- 2013 Treadmills	\$400.00	\$800.00
Estimated Net Total Cost (Items less All Trade-ins)				\$9,190.00



CITY COUNCIL AGENDA ITEM

Date: October 25, 2016

To: Brian Kischnick, City Manager

From: Mark Miller, Director of Economic & Community Development
 MaryBeth Murz, Purchasing Manager
 Elaine Bo, Recreation Director
 Brian Goul, Assistant Recreation Director

Subject: Standard Purchasing Resolution 2: Low Bidder Meeting Specifications - Fitness Equipment

History

- The Community Center Fitness Room offers and maintains sixty two (62) pieces of cardio equipment.
- The fitness equipment is continually monitored and a three to four year life cycle replacement plan is in place based on warranty coverage(s).
- The replacement plan ensures up-to-date equipment for patrons of the fitness room at the Community Center and limited repair expenses.
- Based on the replacement plan it is necessary to purchase and replace eighteen (18) pieces of equipment (less trade-ins) that no longer have warranty coverage and are all past their useful life cycle.
- Replacements are specific to brand to replace brand specific equipment. Patrons enjoy having a variety of different types of equipment.

Purchasing

On October 20, 2016, a bid opening was conducted as required by City Charter and Code for eighteen (18) pieces of physical fitness equipment with one (1) for one (1) trade-in exchange on equipment. For every new piece of equipment purchased by the City from a vendor, that vendor was required to purchase one (1) trade-in. The bid was posted on the Michigan Inter-governmental Trade Network (MITN) website; www.mitn.info. Four (4) bid responses were received which included alternate bid responses. The award is recommended *bid as specified* in order to maintain standardized equipment at the Community Center. Below is a detailed summary of potential vendors:

Companies notified via MITN	26
Troy Companies notified via MITN	0
Troy Companies - Active email Notification	0
Troy Companies - Active Free	0
Companies that viewed the bid	15
Troy Companies that viewed the bid	0

MITN provides a resourceful online platform to streamline the procurement process, reduce costs, and make it easier and more transparent for vendors to do business with the City of Troy. **Active MITN** members with a current membership and paying annual dues receive automatic electronic notification which allows instant access to Bids, RFPS and Quote opportunities with the City. **Active MITN non-paying members** are responsible to monitor and check the MITN website for opportunities to do business with the City. **Inactive MITN member** status can occur when a company does not renew their account upon expiration. Inactive members cannot be notified of solicitations or access any bid information.

After reviewing the bid proposals three (3) companies were the lowest bidders meeting specifications; with a one to one trade-in value on individual items and are being recommended for the purchase of eighteen (18) pieces of physical fitness equipment (less trade-ins). Note that ProMaxima was not considered because they did not offer a one to one trade-in value on equipment and did not bid equipment as specified.





CITY COUNCIL AGENDA ITEM

Financial

The funds for these purchases are available in the Community Center General Operating Supplies Account.

Recommendation

City management recommends awarding three (3) contracts to the low bidders meeting specifications; *Forte Fitness of Ida, MI* for \$9,190.00, *All Pro Exercise of Plymouth Township, MI* for \$46,740.00 and *Direct Fitness Solutions, LLC of Mundelein, IL* for \$9,180.00 as detailed on the following page at an estimated total cost (less one to one trade ins) of \$65,110.00 all at prices contained in the bid tabulation.





CITY COUNCIL AGENDA ITEM

FORTE FITNESS, INC. Ida, MI	ALL PRO EXERCISE Plymouth, MI	DIRECT FITNESS SOLUTIONS, LLC Mundelein, IL
--------------------------------	----------------------------------	--

PROPOSAL: FURNISH AND INSTALL EIGHTEEN (18) NEW PIECES OF COMMERCIAL GRADE PHYSICAL FITNESS EQUIPMENT IN THE TROY COMMUNITY CENTER FITNESS ROOM IN ACCORDANCE WITH THE ATTACHED SPECIFICATIONS AS FOLLOWS:
EQUIPMENT TO PURCHASE (1 for 1 trade-in exchange)

ITEM	QTY	Description (No Substitutions)	Unit Cost (Each)	Estimated Total Cost	Unit Cost (Each)	Estimated Total Cost	Unit Cost (Each)	Estimated Total Cost
1	2	PreCor Vitality Multi-Press CO24ES	\$1,695.00	\$3,390.00	\$2,195.00	\$4,390.00	\$2,495.00	\$4,990.00
2	2	PreCor Vitality Leg Extension/ Leg Curl CO27ES	\$1,695.00	\$3,390.00	\$2,195.00	\$4,390.00	\$2,495.00	\$4,990.00
3	2	FreeMotion i11.9 Incline Treadmill	\$4,995.00	\$9,990.00	\$4,595.00	\$9,190.00	\$5,495.00	\$10,990.00
4	6	Matrix #T5x-2016, heavy commercial Treadmill	\$4,195.00	\$25,170.00	\$4,795.00	\$28,770.00	\$4,895.00	\$29,370.00
5	3	Matrix A3x heavy commercial Ascent Trainer	\$0.00	\$0.00	\$4,895.00	\$14,685.00	\$4,995.00	\$14,985.00
6	2	Matrix E3x heavy commercial Elliptical	\$3,695.00	\$7,390.00	\$3,595.00	\$7,190.00	\$4,395.00	\$8,790.00
7	1	Octane XR6000 X Ride Seated Total Body Elliptical	\$0.00	\$0.00	\$3,695.00	\$3,695.00	\$4,550.00	\$4,550.00
TOTAL COST FOR NEW EQUIPMENT				\$49,330.00		\$68,615.00		\$78,665.00

QTY	Description	Estimated Trade-In Amount (Each)	Estimated Trade-In Amount Total	Estimated Trade-In Amount (Each)	Estimated Trade-In Amount Total	Estimated Trade-In Amount (Each)	Estimated Trade-In Amount Total
1	Lifefitness Hammer Strength Shoulder Press- 2002	\$200.00	\$200.00	\$225.00	\$225.00	\$200.00	\$200.00
2	Lifefitness Hammer Strength incline Press- 2002	\$200.00	\$200.00	\$225.00	\$225.00	\$200.00	\$200.00
3	Lifefitness Hammer Leg Curl- 2002	\$200.00	\$200.00	\$225.00	\$225.00	\$200.00	\$200.00
4	Lifefitness Hammer Strength Leg Extension- 2002	\$200.00	\$200.00	\$225.00	\$225.00	\$200.00	\$200.00
2	Matrix #T5x- 2013 Treadmills	\$400.00	\$800.00	\$225.00	\$225.00	\$200.00	\$200.00
4	Matrix #T5x- 2013 Treadmills	\$400.00	\$2,400.00	\$700.00	\$4,200.00	\$500.00	\$3,000.00
5	Matrix A3x Ascent Trainers- 2013	\$300.00	\$900.00	\$600.00	\$1,800.00	\$500.00	\$1,500.00
6	Matrix E3x Elliptical- 2013	\$200.00	\$400.00	\$500.00	\$1,000.00	\$500.00	\$1,000.00
7	Octane XR6000 Xride- 2012	\$300.00	\$300.00	\$600.00	\$600.00	\$700.00	\$700.00
DEDUCT:			\$5,200.00		\$8,050.00		\$6,600.00
Estimated Net Total Cost (All Items 1-5 less #6 All Trade-ins)			\$44,130.00		\$60,565.00		\$72,065.00
Estimated low bid as specified or approved equivalent less Trade-in Items:			\$0.00		\$0.00		
			\$0.00		\$35,125.00		#REF!

*Awarded low bid as specified with a 1:1 Trade-in Value.

ITEMS 1 & 2 less trade-ins:			
ITEM 3 less trade-ins:		\$9,190.00	\$9,180.00
ITEMS 4, 5, 6, & 7 less trade-ins:			\$46,740.00
*Grand Total Purchase Amount:		\$65,110.00	



VENDOR NAME:	FORTE FITNESS Ida, MI	ALL PRO EXERCISE Plymouth, MI	DIRECT FITNESS SOLUTIONS, LLC Mundelein, IL
--------------	--------------------------	----------------------------------	--

PROPOSAL: FURNISH AND INSTALL EIGHTEEN (18) NEW PIECES OF COMMERCIAL GRADE PHYSICAL FITNESS EQUIPMENT IN THE TROY COMMUNITY CENTER FITNESS ROOM IN ACCORDANCE WITH THE ATTACHED SPECIFICATIONS AS FOLLOWS:
 EQUIPMENT TO PURCHASE (1 for 1 trade-in exchange)

ITEM	QTY	Description (No Substitutions)	Unit Cost (Each)	Estimated Total Cost	Unit Cost (Each)	Estimated Total Cost	Unit Cost (Each)	Estimated Total Cost
1	2	PreCor Vitality Multi-Press CO24ES	\$1,695.00	\$3,390.00	\$2,195.00	\$4,390.00	\$2,495.00	\$4,990.00
2	2	PreCor Vitality Leg Extension/ Leg Curl CO27ES	\$1,695.00	\$3,390.00	\$2,195.00	\$4,390.00	\$2,495.00	\$4,990.00
3	2	FreeMotion i11.9 Incline Treadmill	\$4,995.00	\$9,990.00	\$4,595.00	\$9,190.00	\$5,495.00	\$10,990.00
4	6	Matrix #T5x-2016, heavy commercial Treadmill	\$4,195.00	\$25,170.00	\$4,795.00	\$28,770.00	\$4,895.00	\$29,370.00
5	3	Matrix A3x heavy commercial Ascent Trainer	\$0.00	\$0.00	\$4,895.00	\$14,685.00	\$4,995.00	\$14,985.00
6	2	Matrix E3x heavy commercial Elliptical	\$3,695.00	\$7,390.00	\$3,595.00	\$7,190.00	\$4,395.00	\$8,790.00
7	1	Octane XR6000 X Ride Seated Total Body Elliptical	\$0.00	\$0.00	\$3,695.00	\$3,695.00	\$4,550.00	\$4,550.00
TOTAL COST FOR NEW EQUIPMENT				\$49,330.00		\$68,615.00		\$78,665.00

QTY	Description	Estimated Trade-In Amount (Each)	Estimated Trade-In Amount Total	Estimated Trade-In (Each)	Estimated Trade-In Amount Total	Estimated Trade-In (Each)	Estimated Trade-In Amount Total
1	Lifefitness Hammer Strength Shoulder Press- 2002	\$200.00	\$200.00	\$225.00	\$225.00	\$200.00	\$200.00
1	Lifefitness Hammer Strength incline Press- 2002	\$200.00	\$200.00	\$225.00	\$225.00	\$200.00	\$200.00
1	Lifefitness Hammer Leg Curl- 2002	\$200.00	\$200.00	\$225.00	\$225.00	\$200.00	\$200.00
1	Lifefitness Hammer Strength Leg Extension- 2002	\$200.00	\$200.00	\$225.00	\$225.00	\$200.00	\$200.00
8	Matrix #T5x- 2013 Treadmills	\$400.00	\$3,200.00	\$700.00	\$5,600.00	\$500.00	\$4,000.00
3	Matrix A3x Ascent Trainers- 2013	\$300.00	\$900.00	\$600.00	\$1,800.00	\$500.00	\$1,500.00
2	Matrix E3x Elliptical- 2013	\$200.00	\$400.00	\$500.00	\$1,000.00	\$500.00	\$1,000.00
1	Octane XR6000 Xride- 2012	\$300.00	\$300.00	\$600.00	\$600.00	\$700.00	\$700.00
DEDUCT:			\$5,200.00		\$9,450.00		\$7,600.00
Estimated Net Total Cost (All Items 1-5 less #6 All Trade-ins)			\$44,130.00		\$59,165.00		\$71,065.00

DESCRIPTIVE LITERATURE: Yes or No	Y	Y	Y
DELIVERY by 12/15/2016: Yes or No	Y	Y	Y
AUTHORIZED DEALER: Yes or No	Y	Y	Y IF ORDERD BY 11/07/16
SERVICE FACILITY LOCATION:			Y
Location:	NOVI, MI	PLYMOUTH MI	SHELBY TWP MI
Miles from Troy	25	35	15
Response Time for Service Calls	24-48 HRS	48 HRS	24-48 HRS
CONTACT INFORMATION: Name	NORM MCGLINNEN	DAN COYER	JERRY SAPUTO
Name	7A-6P	9A-5P M-F	STANDARD BUS HRS
Hours of Operation	734.274.0010	800.525.2739	586.382.6562
24 Hr. Phone	Y	Y	Y
WARRANTY: (3) Years Minimum	Y	Y	Y
All Wear Items	Y	Y	Y
All Parts & Labor Coverage	Y	Y	Y
Free 2nd Day Parts Shipping	Y	Y	Y
Free Service call	Y	Y	Y
CONTRACTORS: Yes or No	Y	Y	Y
REFERENCES: Yes or No	Y	Y	Y
INSURANCE:			
Can meet	X	X	Y
Cannot meet			
TERMS:			
CONDITIONS:	NET 30	NET 30	NET 30
EXCEPTIONS:	Y	NO EXCEPTIONS	Y
ACKNOWLEDGEMENT: Signed Yes or No	Y	Y	Y
COMMENTS (5) Yes or No	Y	N	Y

LOW BIDDER(S) MEETING SPECIFICATIONS.



VENDOR NAME: PROMAXIMA
 Houston, TX

PROPOSAL: FURNISH AND INSTALL EIGHTEEN (18) NEW PIECES OF COMMERCIAL GRADE PHYSICAL FITNESS EQUIPMENT IN THE TROY COMMUNITY CENTER FITNESS ROOM IN ACCORDANCE WITH THE ATTACHED SPECIFICATIONS AS FOLLOWS:

ITEM	QTY	Description (No Substitutions)	Unit Cost (Each)	Estimated Total Cost	Unit Cost (Each)	Estimated Total Cost	Unit Cost (Each)	Estimated Total Cost
1	2	PreCor Vitality Multi-Press CO24ES	\$2,675.00	\$5,350.00				
2	2	PreCor Vitality Leg Extension/ Leg Curl CO27ES	\$2,775.00	\$5,550.00		\$0.00		\$0.00
A/t.	2	FreeMotion i11.9 Incline Treadmill	\$10,250.00	\$20,500.00		\$0.00		\$0.00
3	6	Matrix #T5x-2016, heavy commercial Treadmill	\$4,399.00	\$26,394.00		\$0.00		\$0.00
4	3	Matrix A3x heavy commercial Ascent Trainer	\$3,499.00	\$10,497.00		\$0.00		\$0.00
5	2	Matrix E3x heavy commercial Elliptical	\$4,175.00	\$8,350.00		\$0.00		\$0.00
5	1	Octane XR6000 X Ride Seated Total	\$6,429.00	\$6,429.00		\$0.00		\$0.00
TOTAL COST FOR NEW EQUIPMENT				\$76,641.00		\$0.00		\$0.00
6	TRADE-INS					\$0.00		\$0.00

QTY	Description	Estimated Trade-In Amount (Each)	Estimated Trade-In Amount Total	Estimated Trade-In Amount (Each)	Estimated Trade-In Amount Total	Estimated Trade-In Amount (Each)	Estimated Trade-In Amount Total
1	Lifefitness Hammer Strength Shoulder Press- 2002		\$0.00		\$0.00		\$0.00
1	Lifefitness Hammer Strength incline Press- 2002		\$0.00		\$0.00		\$0.00
1	Lifefitness Hammer Leg Curl- 2002		\$0.00		\$0.00		\$0.00
1	Lifefitness Hammer Strength Leg Extension- 2002		\$0.00		\$0.00		\$0.00
8	Matrix #T5x- 2013 Treadmills		\$0.00		\$0.00		\$0.00
3	Matrix A3x Ascent Trainers- 2013		\$0.00		\$0.00		\$0.00
2	Matrix E3x Elliptical- 2013		\$0.00		\$0.00		\$0.00
1	Octane XR6000 Xride- 2012		\$0.00		\$0.00		\$0.00
DEDUCT:			\$1,800.00		\$0.00		\$0.00
Estimated Net Total Cost (All Items 1-5 less #6 All Trade-ins)				\$74,841.00		\$0.00	\$0.00

SCRIPTIVE LITERATURE: Yes or No
 DELIVERY: Yes or No
 AUTHORIZED DEALER: Yes or No
 SERVICE FACILITY LOCATION:
 Location:
 Miles from Troy
 Response Time for Service Calls
 CONTACT INFORMATION: Name
 Name
 Hours of Operation
 24 Hr. Phone
 WARRANTY: (3) Years Minimum
 All Wear Items
 All Parts & Labor Coverage
 Free 2nd Day Parts Shipping
 Free Service call
 CONTRACTORS: Yes or No
 REFERENCES: Yes or No
 PREFERENCE:
 Can meet
 Cannot meet
 PAYMENT TERMS:
 OPTIONS:
 KNOWLEDGEMENT: Signed Yes or No
 SIGNATURES (5) Yes or No
 SIGNATURES:
 A BACHELOR
 IN GOUL
 IN RIESTERER

Y		
Y		
Y		
NEW BALTIMORE, MD		
19		
48 HRS		
PROMAXIMA		
8AM-5PM		
713-667-9606		
Y		
Y		
N		
N		
Y		
Y		
Y		
NET 30		
BLANK		
Y		
Y		

MBS Murz
 Mary Beth Murz,
 Purchasing Manager



STANDARD PURCHASING RESOLUTION 2 – Low Bidders Meeting Specifications – Fitness Equipment

RESOLVED, That Troy City Council hereby AWARDS three (3) contracts to the low bidders meeting specifications to provide fitness equipment for the Troy Community Center to *Forte Fitness of Ida, MI* for \$9,190.00, *All Pro Exercise of Plymouth Township, MI* for \$46,740.00 and *Direct Fitness Solutions, LLC of Mundelein, IL* for \$9,180.00 as detailed below for an estimated total cost (less one to one trade ins) of \$65,110.00 all at prices contained in the bid tabulation dated October 20, 2016, a copy of which shall be ATTACHED to the original Minutes of this meeting.

	Forte Fitness, Inc.	All Pro Exercise	Direct Fitness Solutions, LLC
TOTAL COST FOR NEW EQUIPMENT	\$9,990.00	\$54,340.00	\$9,980.00
Deduct Trade-Ins	\$800.00	\$7,600.00	\$800.00
Estimated Grand Total Cost bid as specified less Trade-in Items:	<u>\$9,190.00</u>	<u>\$46,740.00</u>	<u>\$9,180.00</u>
Estimated Grand Total Cost:	<u>\$65,110.00</u>		

BE IT FURTHER RESOLVED, That the award is contingent upon the company's submission of properly executed bid and contract documents, including insurance certificates and all other specified requirements.



VENDOR NAME:	FORTE FITNESS	ALL PRO EXERCISE	DIRECT FITNESS SOLUTIONS
	IDA MI	PLYMOUTH MI	MUNDELEIN IL

PROPOSAL: FURNISH AND INSTALL EIGHTEEN (18) NEW PIECES OF COMMERCIAL GRADE PHYSICAL FITNESS EQUIPMENT IN THE TROY COMMUNITY CENTER FITNESS ROOM IN ACCORDANCE WITH THE ATTACHED SPECIFICATIONS AS FOLLOWS:
EQUIPMENT TO PURCHASE (1 for 1 trade-in exchange)

ITEM	QTY	Description (No Substitutions)	Unit Cost (Each)	Estimated Total Cost	Unit Cost (Each)	Estimated Total Cost	Unit Cost (Each)	Estimated Total Cost
1	2	PreCor Vitality Multi-Press CO24ES	\$1,695.00	\$3,390.00	\$2,195.00	\$4,390.00	\$2,495.00	\$4,990.00
2	2	PreCor Vitality Leg Extension/ Leg Curl CO27ES	\$1,695.00	\$3,390.00	\$2,195.00	\$4,390.00	\$2,495.00	\$4,990.00
3	2	FreeMotion i11.9 Incline Treadmill	\$4,995.00	\$9,990.00	\$4,595.00	\$9,190.00	\$5,495.00	\$10,990.00
4	6	Matrix #T5x-2016, heavy commercial Treadmill	\$4,195.00	\$25,170.00	\$4,795.00	\$28,770.00	\$4,895.00	\$29,370.00
5	3	Matrix A3x heavy commercial Ascent Trainer	\$0.00	\$0.00	\$4,895.00	\$14,685.00	\$4,995.00	\$14,985.00
6	2	Matrix E3x heavy commercial Elliptical	\$3,695.00	\$7,390.00	\$3,595.00	\$7,190.00	\$4,395.00	\$8,790.00
7	1	Octane XR6000 X Ride Seated Total Body Elliptical	\$0.00	\$0.00	\$3,695.00	\$3,695.00	\$4,550.00	\$4,550.00
TOTAL COST FOR NEW EQUIPMENT				\$49,330.00		\$68,615.00		\$78,665.00

a, 980
ok

QTY	Description	Estimated Trade-In Amount (Each)	Estimated Trade-In Amount Total	Estimated Trade-In Amount (Each)	Estimated Trade-In Amount Total	Estimated Trade-In Amount (Each)	Estimated Trade-In Amount Total
1	Lifefitness Hammer Strength Shoulder Press- 2002	\$200.00	\$200.00	\$225.00	\$225.00	\$200.00	\$200.00
1	Lifefitness Hammer Strength incline Press- 2002	\$200.00	\$200.00	\$225.00	\$225.00	\$200.00	\$200.00
1	Lifefitness Hammer Leg Curl- 2002	\$200.00	\$200.00	\$225.00	\$225.00	\$200.00	\$200.00
1	Lifefitness Hammer Strength Leg Extension- 2002	\$200.00	\$200.00	\$225.00	\$225.00	\$200.00	\$200.00
8	Matrix #T5x- 2013 Treadmills	\$400.00	\$3,200.00	\$700.00	\$5,600.00	\$500.00	\$4,000.00
3	Matrix A3x Ascent Trainers- 2013	\$300.00	\$900.00	\$600.00	\$1,800.00	\$500.00	\$1,500.00
2	Matrix E3x Elliptical- 2013	\$200.00	\$400.00	\$500.00	\$1,000.00	\$500.00	\$1,000.00
1	Octane XR6000 Xride- 2012	\$300.00	\$300.00	\$600.00	\$600.00	\$700.00	\$700.00
DEDUCT:			\$5,200.00		\$9,450.00		\$7,600.00
Estimated Net Total Cost (All Items 1-5 less #6 All Trade-ins)			\$44,130.00		\$59,165.00		\$71,065.00

DESCRIPTIVE LITERATURE: Yes or No
DELIVERY by 12/15/2016: Yes or No
AUTHORIZED DEALER: Yes or No
SERVICE FACILITY LOCATION:
Location:
Miles from Troy
Response Time for Service Calls
CONTACT INFORMATION: Name
Name
Hours of Operation
24 Hr. Phone
WARRANTY: (3) Years Minimum
All Wear Items
All Parts & Labor Coverage
Free 2nd Day Parts Shipping
Free Service call
CONTRACTORS: Yes or No
REFERENCES: Yes or No
ASSURANCE:
Can meet
Cannot meet
PAYMENT TERMS:
OPTIONS:
ACKNOWLEDGEMENT: Signed Yes or No
MS (5) Yes or No

Y	Y	Y
Y	Y	Y IF ORDERED BY 11/07/16
Y	Y	Y
NOVI, MI	PLYMOUTH MI	SHELBY TWP MI
25	35	15
24-48 HRS	48 HRS	24-48 HRS
NORM MCGLINNEN	DAN COYER	JERRY SAPUTO
7A-6P	9A-5P M-F	STANDARD BUS HRS
734.274.0010	800.525.2739	586.382.6562
Y	Y	Y
Y	Y	Y
Y	Y	Y
Y	Y	Y
Y	Y	Y
X	X	Y
NET 30	NET 30	NET 30
Y	NO EXCEPTIONS	Y
Y	Y	Y
Y	N	Y

LOW BIDDER MEETING SPECIFICATIONS OR APPROVED EQUIVALENT

C:

C:

1. $\frac{1}{2} \times \frac{1}{3} = \frac{1}{6}$
2. $\frac{1}{4} \times \frac{1}{5} = \frac{1}{20}$
3. $\frac{1}{6} \times \frac{1}{7} = \frac{1}{42}$
4. $\frac{1}{8} \times \frac{1}{9} = \frac{1}{72}$
5. $\frac{1}{10} \times \frac{1}{11} = \frac{1}{110}$
6. $\frac{1}{12} \times \frac{1}{13} = \frac{1}{156}$
7. $\frac{1}{14} \times \frac{1}{15} = \frac{1}{210}$
8. $\frac{1}{16} \times \frac{1}{17} = \frac{1}{272}$
9. $\frac{1}{18} \times \frac{1}{19} = \frac{1}{342}$
10. $\frac{1}{20} \times \frac{1}{21} = \frac{1}{420}$

1. $\frac{1}{2} \times \frac{1}{3} = \frac{1}{6}$
2. $\frac{1}{4} \times \frac{1}{5} = \frac{1}{20}$
3. $\frac{1}{6} \times \frac{1}{7} = \frac{1}{42}$
4. $\frac{1}{8} \times \frac{1}{9} = \frac{1}{72}$
5. $\frac{1}{10} \times \frac{1}{11} = \frac{1}{110}$
6. $\frac{1}{12} \times \frac{1}{13} = \frac{1}{156}$
7. $\frac{1}{14} \times \frac{1}{15} = \frac{1}{210}$
8. $\frac{1}{16} \times \frac{1}{17} = \frac{1}{272}$
9. $\frac{1}{18} \times \frac{1}{19} = \frac{1}{342}$
10. $\frac{1}{20} \times \frac{1}{21} = \frac{1}{420}$

1. $\frac{1}{2} \times \frac{1}{3} = \frac{1}{6}$
2. $\frac{1}{4} \times \frac{1}{5} = \frac{1}{20}$
3. $\frac{1}{6} \times \frac{1}{7} = \frac{1}{42}$
4. $\frac{1}{8} \times \frac{1}{9} = \frac{1}{72}$
5. $\frac{1}{10} \times \frac{1}{11} = \frac{1}{110}$
6. $\frac{1}{12} \times \frac{1}{13} = \frac{1}{156}$
7. $\frac{1}{14} \times \frac{1}{15} = \frac{1}{210}$
8. $\frac{1}{16} \times \frac{1}{17} = \frac{1}{272}$
9. $\frac{1}{18} \times \frac{1}{19} = \frac{1}{342}$
10. $\frac{1}{20} \times \frac{1}{21} = \frac{1}{420}$

VENDOR NAME:	PROMAXIMA		
	HOUSTON TX		

PROPOSAL: FURNISH AND INSTALL EIGHTEEN (18) NEW PIECES OF COMMERCIAL GRADE PHYSICAL FITNESS EQUIPMENT IN THE TROY COMMUNITY CENTER FITNESS ROOM IN ACCORDANCE WITH THE ATTACHED SPECIFICATIONS AS FOLLOWS:
EQUIPMENT TO PURCHASE (1 for 1 trade-in exchange)

ITEM	QTY	Description (No Substitutions)	Unit Cost (Each)	Estimated Total Cost	Unit Cost (Each)	Estimated Total Cost	Unit Cost (Each)	Estimated Total Cost
1	2	PreCor Vitality Multi-Press CO24ES	\$2,675.00	\$5,350.00		\$0.00		\$0.00
2	2	PreCor Vitality Leg Extension/ Leg Curl CO27ES	\$2,775.00	\$5,550.00		\$0.00		\$0.00
Alt.	2	FreeMotion i11.9 Incline Treadmill	\$10,250.00	\$20,500.00		\$0.00		\$0.00
3	6	Matrix #T5x-2016, heavy commercial Treadmill	\$4,399.00	\$26,394.00		\$0.00		\$0.00
4	3	Matrix A3x heavy commercial Ascent Trainer	\$3,499.00	\$10,497.00		\$0.00		\$0.00
5	2	Matrix E3x heavy commercial Elliptical	\$4,175.00	\$8,350.00		\$0.00		\$0.00
5	1	Octane XR6000 X Ride Seated Total	\$6,429.00	\$6,429.00		\$0.00		\$0.00
TOTAL COST FOR NEW EQUIPMENT				\$76,641.00		\$0.00		\$0.00
TRADE-INS						\$0.00		\$0.00

QTY	Description	Estimated Trade-In Amount (Each)	Estimated Trade-In Amount Total	Estimated Trade-In Amount (Each)	Estimated Trade-In Amount Total	Estimated Trade-In Amount (Each)	Estimated Trade-In Amount Total
1	Lifefitness Hammer Strength Shoulder Press- 2002		\$0.00		\$0.00		\$0.00
1	Lifefitness Hammer Strength incline Press- 2002		\$0.00		\$0.00		\$0.00
1	Lifefitness Hammer Leg Curl- 2002		\$0.00		\$0.00		\$0.00
1	Lifefitness Hammer Strength Leg Extension- 2002		\$0.00		\$0.00		\$0.00
8	Matrix #T5x- 2013 Treadmills		\$0.00		\$0.00		\$0.00
3	Matrix A3x Ascent Trainers- 2013		\$0.00		\$0.00		\$0.00
2	Matrix E3x Elliptical- 2013		\$0.00		\$0.00		\$0.00
1	Octane XR6000 Xride- 2012		\$0.00		\$0.00		\$0.00
	DEDUCT:		\$1,800.00		\$0.00		\$0.00
Estimated Net Total Cost (All Items 1-5 less #6 All Trade-ins)			\$74,841.00		\$0.00		\$0.00

DESCRIPTIVE LITERATURE: Yes or No

DELIVERY: Yes or No

AUTHORIZED DEALER: Yes or No

SERVICE FACILITY LOCATION:

Location:

Miles from Troy

Response Time for Service Calls

CONTACT INFORMATION: Name

Name

Hours of Operation

24 Hr. Phone

WARRANTY: (3) Years Minimum

All Wear Items

All Parts & Labor Coverage

Free 2nd Day Parts Shipping

Free Service call

SUBCONTRACTORS: Yes or No

REFERENCES: Yes or No

INSURANCE:

Can meet

Cannot meet

PAYMENT TERMS:

EXCEPTIONS:

ACKNOWLEDGEMENT: Signed Yes or No

FORMS (5) Yes or No

TEST:

ANA BACHELOR

RIAN GOUL

SAN RIESTERER

Y		
Y		
Y		
	NEW BALTIMORE MI	
	19	
	48 HRS	
	PROMAXIMA	
	8AM-5PM	
	713-667-9606	
	Y	
	Y	
	N	
	N	
	Y	
	Y	
	Y	
	NET 30	
	BLANK	
	Y	
	Y	

Mary Beth Murz,
 Purchasing Manager

VENDOR NAME:	FORTE FITNESS IDA MI	ALL PRO EXERCISE PLYMOUTH MI	DIRECT FITNESS SOLUTIONS MUNDELEIN IL
--------------	-------------------------	---------------------------------	--

PROPOSAL: FURNISH AND INSTALL EIGHTEEN (18) NEW PIECES OF COMMERCIAL GRADE PHYSICAL FITNESS EQUIPMENT IN THE TROY COMMUNITY CENTER FITNESS ROOM IN ACCORDANCE WITH THE ATTACHED SPECIFICATIONS AS FOLLOWS:
EQUIPMENT TO PURCHASE (1 for 1 trade-in exchange)

ITEM	QTY	Description (No Substitutions)	Unit Cost (Each)	Estimated Total Cost	Unit Cost (Each)	Estimated Total Cost	Unit Cost (Each)	Estimated Total Cost
1	2	PreCor Vitality Multi-Press CO24ES	\$1,695.00	\$3,390.00	\$2,195.00	\$4,390.00	\$2,495.00	\$4,990.00
2	2	PreCor Vitality Leg Extension/ Leg Curl CO27ES	\$1,695.00	\$3,390.00	\$2,195.00	\$4,390.00	\$2,495.00	\$4,990.00
3	2	FreeMotion i11.9 Incline Treadmill	\$4,995.00	\$9,990.00	\$4,595.00	\$9,190.00	\$5,495.00	\$10,990.00
4	6	Matrix #T5x-2016, heavy commercial Treadmill	\$4,195.00	\$25,170.00	\$4,795.00	\$28,770.00	\$4,895.00	\$29,370.00
5	3	Matrix A3x heavy commercial Ascent Trainer	\$0.00	\$0.00	\$4,895.00	\$14,685.00	\$4,995.00	\$14,985.00
6	2	Matrix E3x heavy commercial Elliptical	\$3,695.00	\$7,390.00	\$3,595.00	\$7,190.00	\$4,395.00	\$8,790.00
7	1	Octane XR6000 X Ride Seated Total Body Elliptical	\$0.00	\$0.00	\$3,695.00	\$3,695.00	\$4,550.00	\$4,550.00
TOTAL COST FOR NEW EQUIPMENT				\$49,330.00		\$68,615.00		\$78,665.00

TRADE-INS		Estimated Trade-In Amount (Each)	Estimated Trade-In Amount Total	Estimated Trade-In Amount (Each)	Estimated Trade-In Amount Total	Estimated Trade-In Amount (Each)	Estimated Trade-In Amount Total
1	Lifefitness Hammer Strength Shoulder Press- 2002	\$200.00	\$200.00	\$225.00	\$225.00	\$200.00	\$200.00
1	Lifefitness Hammer Strength incline Press- 2002	\$200.00	\$200.00	\$225.00	\$225.00	\$200.00	\$200.00
1	Lifefitness Hammer Leg Curl- 2002	\$200.00	\$200.00	\$225.00	\$225.00	\$200.00	\$200.00
1	Lifefitness Hammer Strength Leg Extension- 2002	\$200.00	\$200.00	\$225.00	\$225.00	\$200.00	\$200.00
8	Matrix #T5x- 2013 Treadmills	\$400.00	\$3,200.00	\$700.00	\$5,600.00	\$500.00	\$4,000.00
3	Matrix A3x Ascent Trainers- 2013	\$300.00	\$900.00	\$600.00	\$1,800.00	\$500.00	\$1,500.00
2	Matrix E3x Elliptical- 2013	\$200.00	\$400.00	\$500.00	\$1,000.00	\$500.00	\$1,000.00
1	Octane XR6000 Xride- 2012	\$300.00	\$300.00	\$600.00	\$600.00	\$700.00	\$700.00
DEDUCT:			\$5,200.00		\$9,450.00		\$7,600.00
Estimated Net Total Cost (All items 1-5 less #6 All Trade-ins)			\$44,130.00		\$59,165.00		\$71,065.00

DESCRIPTIVE LITERATURE: Yes or No	Y	Y	Y
DELIVERY by 12/15/2016: Yes or No	Y	Y	Y IF ORDERD BY 11/07/16
AUTHORIZED DEALER: Yes or No	Y	Y	Y
SERVICE FACILITY LOCATION:			
Location:	NOVI, MI	PLYMOUTH MI	SHELBY TWP MI
Miles from Troy	25	35	15
Response Time for Service Calls	24-48 HRS	48 HRS	24-48 HRS
CONTACT INFORMATION: Name			
Name	NORM MCGLINNEN	DAN COYER	JERRY SAPUTO
Hours of Operation	7A-6P	9A-5P M-F	STANDARD BUS HRS
24 Hr. Phone	734.274.0010	800.525.2739	586.382.6562
WARRANTY: (3) Years Minimum			
All Wear Items	Y	Y	Y
All Parts & Labor Coverage	Y	Y	Y
Free 2nd Day Parts Shipping	Y	Y	Y
Free Service call	Y	Y	Y
CONTRACTORS: Yes or No	Y	Y	Y
REFERENCES: Yes or No	Y	Y	Y
INSURANCE:			
Can meet			
Cannot meet	X	X	Y
PAYMENT TERMS:			
DECEPTIONS:	NET 30	NET 30	NET 30
KNOWLEDGEMENT: Signed Yes or No	Y	NO EXCEPTIONS	Y
TERMS (5) Yes or No	Y	Y	Y
	Y	N	Y

LOW BIDDER MEETING SPECIFICATIONS OR APPROVED EQUIVALENT

VENDOR NAME:	PROMAXIMA	
	HOUSTON TX	

PROPOSAL: FURNISH AND INSTALL EIGHTEEN (18) NEW PIECES OF COMMERCIAL GRADE PHYSICAL FITNESS EQUIPMENT IN THE TROY COMMUNITY CENTER FITNESS ROOM IN ACCORDANCE WITH THE ATTACHED SPECIFICATIONS AS FOLLOWS:

EQUIPMENT TO PURCHASE (1 for 1 trade-in exchange)

ITEM	QTY	Description (No Substitutions)	Unit Cost (Each)	Estimated Total Cost	Unit Cost (Each)	Estimated Total Cost	Unit Cost (Each)	Estimated Total Cost
1	2	PreCor Vitality Multi-Press CO24ES	\$2,675.00	\$5,350.00		\$0.00		\$0.00
2	2	PreCor Vitality Leg Extension/ Leg Curl CO27ES	\$2,775.00	\$5,550.00		\$0.00		\$0.00
A/t.	2	FreeMotion i11.9 Incline Treadmill	\$10,250.00	\$20,500.00		\$0.00		\$0.00
3	6	Matrix #T5x-2016, heavy commercial Treadmill	\$4,399.00	\$26,394.00		\$0.00		\$0.00
4	3	Matrix A3x heavy commerical Ascent Trainer	\$3,499.00	\$10,497.00		\$0.00		\$0.00
5	2	Matrix E3x heavy commercial Elliptical	\$4,175.00	\$8,350.00		\$0.00		\$0.00
5	1	Octane XR6000 X Ride Seated Total	\$6,429.00	\$6,429.00		\$0.00		\$0.00
TOTAL COST FOR NEW EQUIPMENT				\$76,641.00		\$0.00		\$0.00
TRADE-INS						\$0.00		\$0.00

QTY	Description	Estimated Trade-In Amount (Each)	Estimated Trade-In Amount Total	Estimated Trade-In Amount (Each)	Estimated Trade-In Amount Total	Estimated Trade-In Amount (Each)	Estimated Trade-In Amount Total
1	Lifefitness Hammer Strength Shoulder Press- 2002		\$0.00		\$0.00		\$0.00
1	Lifefitness Hammer Strength incline Press- 2002		\$0.00		\$0.00		\$0.00
1	Lifefitness Hammer Leg Curl- 2002		\$0.00		\$0.00		\$0.00
1	Lifefitness Hammer Strength Leg Extension- 2002		\$0.00		\$0.00		\$0.00
8	Matrix #T5x- 2013 Treadmills		\$0.00		\$0.00		\$0.00
3	Matrix A3x Ascent Trainers- 2013		\$0.00		\$0.00		\$0.00
2	Matrix E3x Elliptical- 2013		\$0.00		\$0.00		\$0.00
1	Octane XR6000 Xride- 2012		\$0.00		\$0.00		\$0.00
	DEDUCT:		\$1,800.00		\$0.00		\$0.00
Estimated Net Total Cost (All Items 1-5 less #6 All Trade-ins)			\$74,841.00		\$0.00		\$0.00

DESCRIPTIVE LITERATURE: Yes or No

DELIVERY: Yes or No

AUTHORIZED DEALER: Yes or No

SERVICE FACILITY LOCATION:

Location:
 Miles from Troy
 Response Time for Service Calls

CONTACT INFORMATION: Name

Name
 Hours of Operation
 24 Hr. Phone

WARRANTY: (3) Years Minimum

All Wear Items
 All Parts & Labor Coverage
 Free 2nd Day Parts Shipping
 Free Service call

UBCONTRACTORS: Yes or No

REFERENCES: Yes or No

SURANCE:

Can meet
 Cannot meet

AYMENT TERMS:

CEPTIONS:

KNOWLEDGEMENT: Signed Yes or No

RMS (5) Yes or No

TEST:

INA BACHELOR

IAN GOUL

SAN RIESTERER

Y		
Y		
Y		
	NEW BALTIMORE MI	
	19	
	48 HRS	
	PROMAXIMA	
	8AM-5PM	
	713-667-9606	
Y		
Y		
N		
N		
Y		
Y		
Y		
	NET 30	
	BLANK	
	Y	
	Y	

Mary Beth Murz,
 Purchasing Manager

VENDOR NAME: All Pro Exercise Plymouth TWP Direct Fitness Solutions Forke Fitness Tota MI

PROPOSAL: FURNISH AND INSTALL EIGHTEEN (18) NEW PIECES OF COMMERCIAL GRADE PHYSICAL FITNESS EQUIPMENT IN THE TROY COMMUNITY CENTER FITNESS ROOM IN ACCORDANCE WITH THE ATTACHED SPECIFICATIONS AS FOLLOWS:
 EQUIPMENT TO PURCHASE (1 for 1 trade-in exchange)

ITEM	QTY	Description (No Substitutions)	Unit Cost (Each)	Estimated Total Cost	Unit Cost (Each)	Estimated Total Cost	Unit Cost (Each)	Estimated Total Cost
1	2	PreCor Vitality Multi-Press CO24ES	2,195	4,390	2,195			
2	2	PreCor Vitality Leg Extension/ Leg Curl CO27ES	2,195	4,390	2,195	\$0.00		\$0.00
3	2	FreeMotion i11.9 Incline Treadmill	4,595	9,190	4,595	\$0.00		\$0.00
4	6	Matrix #T5x-2016, heavy commercial Treadmill	4,795	28,770	4,795	\$0.00		\$0.00
5	3	Matrix A3x heavy commercial Ascent Trainer	4,895	14,685		\$0.00		\$0.00
6	2	Matrix E3x heavy commercial Elliptical	3,595	7,190		\$0.00		\$0.00
7	1	Octane XR6000 X Ride Seated Total Body Elliptical	3,695	3,695		\$0.00		\$0.00
TOTAL COST FOR NEW EQUIPMENT								
8		TRADE-INS		\$0.00		\$0.00		\$0.00

QTY	Description	Estimated Trade-In Amount (Each)	Estimated Trade-In Amount Total	Estimated Trade-In Amount (Each)	Estimated Trade-In Amount Total	Estimated Trade-In Amount (Each)	Estimated Trade-In Amount Total
1	Lifefitness Hammer Strength Shoulder Press- 2002	225	\$0.00		\$0.00		\$0.00
1	Lifefitness Hammer Strength incline Press- 2002	225					200
1	Lifefitness Hammer Leg Curl- 2002	225	\$0.00		\$0.00		200
1	Lifefitness Hammer Strength Leg Extension- 2002	225	\$0.00		\$0.00		\$0.00
8	Matrix #T5x- 2013 Treadmills	700	5,600		\$0.00		\$0.00
3	Matrix A3x Ascent Trainers- 2013	600	1,800		\$0.00		\$0.00
2	Matrix E3x Elliptical- 2013	500	1,000		\$0.00		\$0.00
1	Octane XR6000 Xride- 2012	600	600		\$0.00		\$0.00
	DEDUCT:						
	Estimated Net Total Cost (All Items 1-5 less #6 All Trade-ins)		9,900				43,630

3,390
 3,390
 9,190
 25,170
 3,390
 300
 200
 200
 200
 200
 300
 300
 300
 300
 300
 5,180
 5,180

DESCRIPTIVE LITERATURE: Yes or No
 DELIVERY by August 29, 2014: Yes or No
 AUTHORIZED DEALER: Yes or No
 SERVICE FACILITY LOCATION:
 Location:
 Miles from Troy
 Response Time for Service Calls
 CONTACT INFORMATION: Name
 Name
 Hours of Operation
 24 Hr. Phone
 WARRANTY: (3) Years Minimum
 All Wear Items
 All Parts & Labor Coverage
 Free 2nd Day Parts Shipping
 Free Service call
 CONTRACTORS: Yes or No
 REFERENCES: Yes or No
 GUARANTEE:
 Can meet
 Cannot meet
 PAYMENT TERMS:
 CONDITIONS:
 KNOWLEDGEMENT: Signed Yes or No
 SIGNATURES (5) Yes or No

LOW BIDDER MEETING SPECIFICATIONS OR APPROVED EQUIVALENT



VENDOR NAME: Pro Maxima Houston TX

PROPOSAL: FURNISH AND INSTALL EIGHTEEN (18) NEW PIECES OF COMMERCIAL GRADE PHYSICAL FITNESS EQUIPMENT IN THE TROY COMMUNITY CENTER FITNESS ROOM IN ACCORDANCE WITH THE ATTACHED SPECIFICATIONS AS FOLLOWS:

EQUIPMENT TO PURCHASE (1 for 1 trade-in exchange)

ITEM	QTY	Description (No Substitutions)	Unit Cost (Each)	Estimated Total Cost	Unit Cost (Each)	Estimated Total Cost	Unit Cost (Each)	Estimated Total Cost
1	2	PreCor Vitality Multi-Press CO24ES	No Bid	5,350		\$0.00		
2	2	PreCor Vitality Leg Extension/ Leg Curl CO27ES		5,550				
Alt.	2	FreeMotion i11.9 Incline Treadmill		20,300		\$0.00		
3	6	Matrix #T5x-2016, heavy commercial Treadmill		26,394		\$0.00		
4	3	Matrix A3x heavy commercial Ascent Trainer		10,497		\$0.00		
5	2	Matrix E3x heavy commercial Elliptical		\$0.00				
5	1	Octane XR6000 X Ride Seated Total		6429		\$0.00		
TOTAL COST FOR NEW EQUIPMENT				\$0.00		\$0.00		

TRADE-INS								
QTY	Description	Estimated Trade-In Amount (Each)	Estimated Trade-In Amount Total	Estimated Trade-In Amount (Each)	Estimated Trade-In Amount Total	Estimated Trade-In Amount (Each)	Estimated Trade-In Amount Total	Estimated Trade-In Amount Total
1	Lifefitness Hammer Strength Shoulder Press- 2002		\$0.00		\$0.00			
1	Lifefitness Hammer Strength incline Press- 2002		\$0.00		\$0.00			
1	Lifefitness Hammer Leg Curl- 2002		\$0.00		\$0.00			
1	Lifefitness Hammer Strength Leg Extension- 2002		\$0.00		\$0.00			
8	Matrix #T5x- 2013 Treadmills							
3	Matrix A3x Ascent Trainers- 2013		\$0.00		\$0.00			
2	Matrix E3x Elliptical- 2013				\$0.00			
1	Octane XR6000 Xride- 2012		\$0.00		\$0.00			
	DEDUCT:		\$0.00		\$0.00			
Estimated Net Total Cost (All Items 1-5 less #6 All Trade-ins)			\$0.00		\$0.00			

DESCRIPTIVE LITERATURE: Yes or No

DELIVERY: Yes or No

AUTHORIZED DEALER: Yes or No

SERVICE FACILITY LOCATION:

Location:
 Miles from Troy
 Response Time for Service Calls

CONTACT INFORMATION: Name

Name
 Hours of Operation
 24 Hr. Phone

WARRANTY: (3) Years Minimum

All Wear Items
 All Parts & Labor Coverage
 Free 2nd Day Parts Shipping
 Free Service call

SUBCONTRACTORS: Yes or No

REFERENCES: Yes or No

INSURANCE:

Can meet
 Cannot meet

PAYMENT TERMS:

EXCEPTIONS:

ACKNOWLEDGEMENT: Signed Yes or No

FORMS (5) Yes or No

TEST:

[Handwritten signatures and initials]

Mary Beth Murz,
 Purchasing Manager

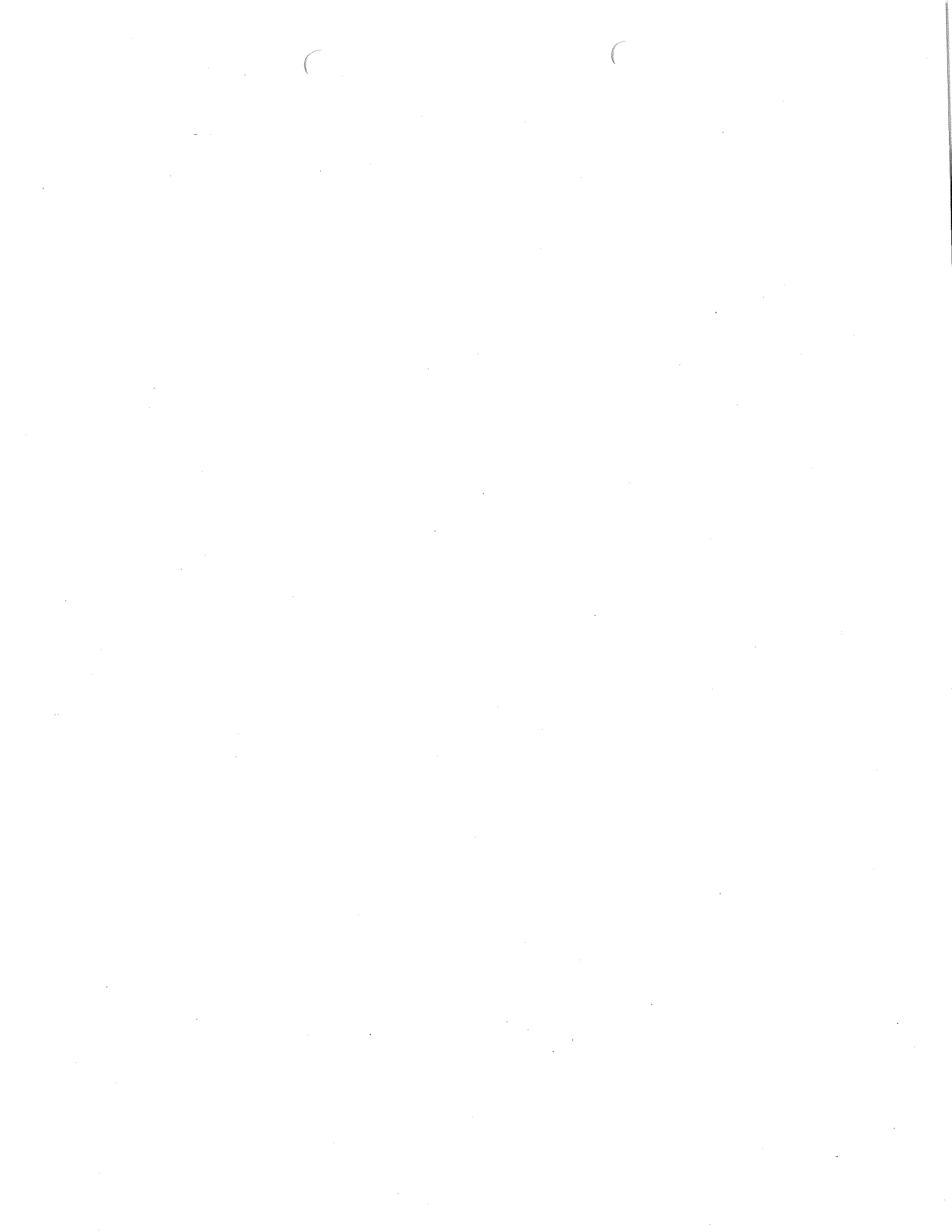



Enna A. Bachelor

From: Enna A. Bachelor
Sent: Wednesday, October 05, 2016 3:02 PM
To: 'WSteigelman@directfitnesssolutions.com'
Subject: ITB-COT 16-35 PHYSICAL FITNESS EQUIPMENT FOR THE CITY OF TROY, MI DUE 10/20/2016
Attachments: ITB-COT 16-35 FitnessEquipment_2016.pdf

Sealed proposals for the Purchase and Installation of **PHYSICAL FITNESS EQUIPMENT FOR THE TROY COMMUNITY CENTER LESS TRADE-INS**, will be received by the City of Troy at the office of the City Clerk, 500 W. Big Beaver Road, Troy, MI 48084 until **THURSDAY, OCTOBER 20, 2016 at 10:00 AM, EDT** after which time they will be publicly opened and read in the Troy City Offices. **Late bid submittals will not be accepted. Bid responses are not accepted via fax transmission.**

Please refer to the attached bid documents for more information.

ENNA A. BACHELOR | BUYER

City of Troy | 500 W. Big Beaver, Troy, MI 48084 | Office: 248-524-3576 | troymi.gov  

"We believe a strong community embraces diversity, promotes innovation, and encourages collaboration. We strive to lead by example within the region. We do this because we want everyone to choose Troy as their community for life. We believe in doing government the best."

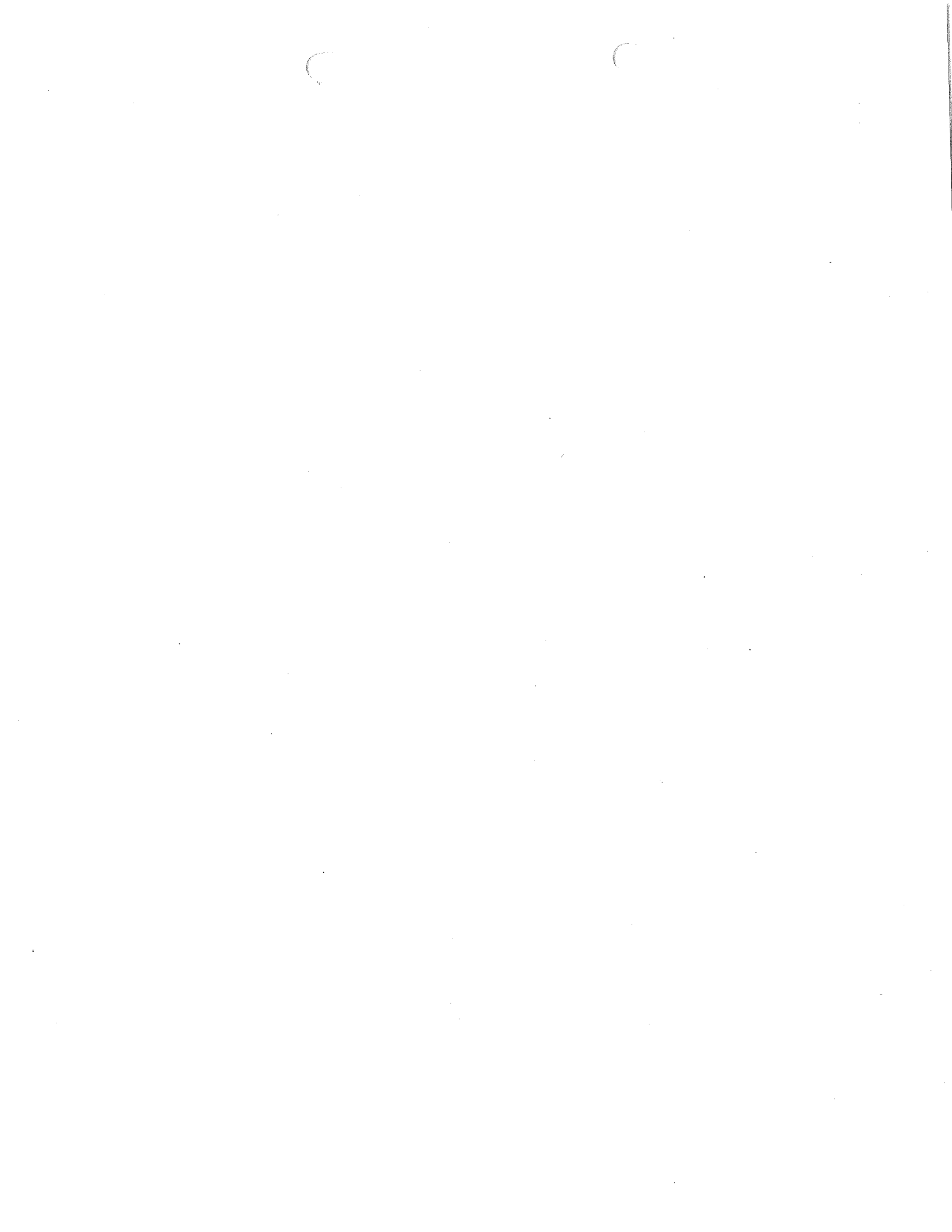





**CITY OF TROY
BID PROPOSAL**

ITB-COT 16-35
Page 1 of 6

The undersigned proposes to purchase and install **NEW PHYSICAL FITNESS EQUIPMENT FOR THE TROY COMMUNITY CENTER LESS TRADE-INS**, in accordance with the specifications, which are to be considered an integral part of this proposal, at the following prices:

COMPANY NAME: Forte Fitness Inc.

PROPOSAL: TO PURCHASE AND INSTALL EIGHTEEN (18) PIECES OF PHYSICAL FITNESS EQUIPMENT FOR THE TROY COMMUNITY CENTER FITNESS ROOM LESS TRADE-INS IN ACCORDANCE WITH THE ATTACHED SPECIFICATIONS AS FOLLOWS:

The undersigned, as bidder, declares that he/she has examined the specifications, including related documents. Being familiar with the conditions in the City of Troy and the type of work required, the bidder hereby proposes to furnish all labor, materials, equipment and supplies, to provide the services specified in the bid proposal documents, at the prices stated below. These prices are to cover all expenses incurred in performing the work required:

		EQUIPMENT TO PURCHASE (1 for 1 trade-in exchange)		
	Quantity	Description (No Substitutions)	Unit Cost (Each)	Estimated Total Cost
1	Two (2)	PreCor Vitality Multi-Press CO24ES	\$ 1695.- /ea	\$ 3390. ⁰⁰
2	Two (2)	PreCor Vitality Leg Extension/Leg Curl CO27ES	\$ 1695.- /ea	\$ 3390. ⁰⁰
3	Two (2)	FreeMotion i11.9 Incline Treadmill	\$ 4995.- /ea	\$ 9990. ⁰⁰
4	Six (6)	Matrix #T5x-2016, heavy commercial treadmill	\$ 4195.- /ea	\$ 25,170. ⁰⁰
5	Three (3)	Matrix A3x heavy commercial Ascent Trainer	\$ /ea	\$
6	Two (2)	Matrix E3x heavy commercial Elliptical	\$ 3695.- /ea	\$ 7390. ⁰⁰
7	One (1)	Octane XR6000 X Ride Seated Total Body Elliptical	\$ /ea	\$
8	TRADE-INS			
	Quantity	Description	Estimated Trade-In Amount (Each)	Estimated Trade-In Amount Total
	One (1)	Lifefitness Hammer Strength Shoulder Press - 2002	(\$ 200. ⁰⁰)	(\$ 200)
	One (1)	Lifefitness Hammer Strength Incline Press-2002	(\$ 200. ⁰⁰)	(\$ 200)
	One (1)	Lifefitness Hammer Strength Leg Curl - 2002	(\$ 200. ⁰⁰)	(\$ 200)
	One (1)	Lifefitness Hammer Strength Leg Extension-2002	200. ⁰⁰	200
	Eight (8)	Matrix #T5x - 2013 Treadmills	(\$ 400. ⁰⁰)	(\$ 3200)
	Three (3)	Matrix A3x Ascent Trainers - 2013	(\$ 300. ⁰⁰)	(\$ 900)
	Two (2)	Matrix E3x Elliptical - 2013	(\$ 200. ⁰⁰)	(\$ 600)
	One (1)	Octane XR6000 XRide - 2012	(\$ 300. ⁰⁰)	(\$ 300)
		DEDUCT:	(\$)	(\$ 5700)
			Estimated Net Total Cost	\$ 43630. ⁰⁰



Norm McGlennen

734-274-0010
norm@fortefitusa.com

1965 Ida Center Rd.
Ida, MI 48140
www.fortefitusa.com

IMPORTANT:

In order to be considered for an award and your company is bidding on any items 1 – 7; it is **required** that items listed **under Item #8** as a Trade-in have a corresponding purchase price.

The City intends to award this bid on a (1) one for (1) one exchange. For every piece of equipment purchased by the City from a vendor, that vendor **will be required** to purchase one (1) trade-in from the equipment listed under Item #8. The decision as to which trade-ins will be awarded to what vendor will be made in the City of Troy's best interest and will be final.

NOTE: Include all delivery costs, handling, packaging, and service charges.

UNIT PRICES:

Unit prices prevail. The City of Troy Purchasing Department will correct all mathematical errors.

DESCRIPTIVE LITERATURE:

Please attach descriptive or pertinent literature relevant to your company's bid proposal at the time of bid submission. It is attached and marked Forte Fitness for your identification.

ADDITIONAL INFORMATION:

For questions about the specifications, please contact **Mr. Brian Goul**, Assistant Recreation Director at **(248) 524-3484**, between the hours of 8:00 AM and 4:30 PM, Monday through Friday.

DELIVERY:

All items are to be F.O.B. delivered, freight paid with inside delivery, to the Troy Community Center, 3179 Livernois Rd, Troy, MI 48083, ATTN: Brian Goul.

DELIVERY SCHEDULE:

It is preferred all equipment be delivered and installed at the Troy Community Center **by December 15, 2016**. It will be the successful bidder's responsibility to work with the department representative to establish an acceptable delivery and installation schedule. Installation shall be within two (2) business days after receipt of the equipment at the City's location. The equipment should not be delivered to the City's site unless the equipment is to be installed and made ready for use within the above parameters. The City of Troy is the only party to this contract that may authorize amendment to this schedule.

- Our Company can meet this delivery and installation schedule
- Our company cannot meet this delivery and installation schedule but offers: _____

DOWN-PAYMENTS OR PREPAYMENTS:

Any bid proposal submitted which requires a down-payment or prepayment prior to delivery and full acceptance of the item(s) as being in conformance with specifications will not be considered for award.

AWARD:

The evaluation and award of this bid shall be a combination of factors, including but not limited to: cost, professional competence, equipment as specified, warranties, and the correlation of the proposal submitted to the needs of the City of Troy.

The City of Troy reserves the right to award this bid to the lowest responsible bidder(s) meeting specifications for the purchase of Physical Fitness Equipment when combined with an equal number of equipment pieces from the trade-in list under Item #7, or to combine the items in whatever manner is deemed to be in the City of Troy's best interest; to reject low bids which have major deviations from the specifications; to accept a higher bid which has only minor deviations; to accept or reject the trade-in offers.

COMPANY NAME: Forte Fitness Inc

LOCAL PREFERENCE:

The City of Troy reserves the right to award a contract to a local business, one which pays City of Troy taxes (real and/or personal), if the bid of a local vendor is within 5% of the lowest responsive and responsible non-local bidder, then the local vendor is given one chance to match the low bid.

PURCHASE ORDER:

After approval of the successful bidder(s) by the Troy City Council, the purchase order issued from the City of Troy will create a bilateral contract between the parties and commit the successful bidder(s) to perform the contract in accordance with specifications. The Purchase orders will be released upon the City's acceptance of the specified insurance. A contract document/ agreement will not be issued.

CONTRACT FORMS:

Bidders should complete the Legal Status of Bidder, Non-Collusion Affidavit, Certification regarding Debarment and the Certification regarding "Iran Linked Business" forms and return with your bid proposal.

AUTHORIZED DEALER:

- Our company is an authorized distributor of the equipment specified
- Our company is not an authorized distributor of the equipment specified

SERVICE FACILITY:

Location: Novi Michigan

Number of miles from City of Troy: 25 miles

Response Time for Service Calls: Within 24-48 hours to be onsite after initial request for service by a factory trained technician. (Number)

CONTACT INFORMATION:

Name(s): Norm McGlinnon

24 Hr. Phone No. 734-274-0010

Hours of operation: 7am to 6pm

WARRANTY:

Please indicate the warranty items included in the bid price for the equipment bid. Each item must be completed with a Yes or No response.

WARRANTY DESCRIPTION	WARRANTY DURATION (Minimum)	INCLUDED	
		YES	NO
All "wear items"	3 Years	<input checked="" type="checkbox"/>	<input type="checkbox"/>
All parts and labor coverage	3 Years	<input checked="" type="checkbox"/>	<input type="checkbox"/>
Free second day parts shipping	3 Years	<input checked="" type="checkbox"/>	<input type="checkbox"/>
Free service call and technician travel at no additional cost to the City	3 Years	<input checked="" type="checkbox"/>	<input type="checkbox"/>

If your company can supply the warranty as described at an additional cost, please indicate this on supporting documentation marked _____ for identification.

SUBCONTRACTORS:

Service and warranty work cannot be subcontracted. The successful bidders(s) must be able to service and repair the equipment bid with in-house personnel.

Our Company complies with this requirement: (Circle one) YES or NO

COMPANY NAME: FORTE FITNESS

- 1 LMHARKE@umich.edu
 2 McNeil@msu.edu
 3 MDubby@Adrian.edu

REFERENCES:

Please submit a list of *THREE CUSTOMERS* that currently use the make and model of the equipment bid. Include the name of the company, the address, phone number, contact person and email. The references are as follows:

COMPANY	ADDRESS	CONTACT PERSON	EMAIL	PHONE	YEAR PURCHASED
UofMichigan	CCRB	Lisa Shea	1	734-936-0602	2016
MSU	Campus Rec	Rick McNeil	2	517-432-1514	2016
Adrian College	ATHLETICS	Mike Dubby	3	517-264-3997	2014

INSURANCE:

Insurance requirements shall be in accordance with the attached **SAMPLE INSURANCE CERTIFICATE** and **ENDORSEMENT**. The required Insurance Certificate and Endorsement must be submitted to the city within 5 days of the verbal/ electronic request after the bid award. The Insurance Certificate and Endorsement may be faxed to the Purchasing Office at (248) 619-7608, and is the only bid document accepted in this format.

The contractor, or any of their subcontractors, shall not commence work under this contract until they have obtained the insurance required, and shall keep such insurance in force during the entire life of this contract. All coverage shall be with insurance companies licensed and admitted to business in the State of Michigan and acceptable to the City of Troy. The requirements below should not be interpreted to limit the liability of the Contractor. All deductibles and self-insured retentions (SIR's) are the responsibility of the Contractor.

- We can meet the specified insurance requirements.
- We cannot meet the specified insurance requirements.
- We do not carry the specified limits but can obtain the additional insurance coverage of \$ _____, at the cost of \$ _____.
NOTE: Please note the amendments on a sample insurance certificate and attach it to your bid proposal.
- Our proposal is reduced by \$ _____ if we lower the requirement to \$ _____.
NOTE: Please note the amendments on a sample insurance certificate and attach it to your bid proposal.

IMPORTANT: A Certificate of Insurance on an ACORD Form showing present coverage as well as the required endorsements SHALL be attached to the proposal document at the time of submission of the proposal to the Office of the City Clerk.

NOTE: Failure on the part of any bidder to contact his/her insurance carrier to verify that the insurance carried by the bidder meets City of Troy specifications may result in this proposal being completed incorrectly.

OTHER: Sole proprietors must execute a certificate of exemption from Worker's Compensation requirements or provide proof of Worker's Compensation Insurance. All coverage shall be with insurance carriers licensed and admitted to do business in Michigan in accordance with all applicable statutes of the State of Michigan and acceptable to the City of Troy.

INSURANCE VERIFICATION:

A bidder shall complete the above portion, which details additional costs that may be incurred for specified coverage without purchasing the additional coverage prior to bid submission.

COMPANY NAME: Forke Fitness

WORKERS' COMPENSATION INSURANCE, including Employers' Liability Coverage, in accordance with all applicable statutes of the State of Michigan.

COMMERCIAL GENERAL LIABILITY INSURANCE on an "Occurrence Basis" with limits of liability not less than \$1,000,000.00 per occurrence and aggregate. Coverage shall include the following extensions: (A) Contractual liability; (B) Products and Completed Operations; (C) Independent Contractors Coverage; (D) Broad Form General Liability Extensions or equivalent, if not already included; (E) Deletion of all Explosion, Collapse, and Underground (XCU) Exclusions, if applicable.

AUTOMOBILE LIABILITY, including Michigan No-Fault Coverages, with limits of liability not less than \$1,000,000.00 per occurrence combined single limit for Bodily Injury, and Property Damage. Coverage shall include all owned vehicles, all non-owned vehicles, and all hired vehicles.

ADDITIONAL INSURED:

Commercial General Liability and Automobile Liability, as described in the attached SAMPLE shall include an Additional Insured Endorsement stating the following shall be ***Additional Insureds***: The City of Troy including all elected and appointed officials, all employees and volunteers, all boards, commissions, and/or authorities and council members, including employees and volunteers thereof. It is understood and agreed by naming the City of Troy as additional insured, coverage afforded is considered to be primary and any other insurance the City of Troy may have in effect shall be considered secondary and/or excess.

CANCELLATION NOTICE:

All policies, as described above, shall include an endorsement stating that it is understood and agreed that Thirty (30) days, Ten (10) days for non-payment of premium, Advance Written Notice of Cancellation, Non-Renewal, Reduction, and/or Material Change shall be mailed to:

City of Troy
Purchasing Manager
500 West Big Beaver
Troy, MI 48084

PROOF OF INSURANCE COVERAGE:

The Contractor shall provide the City of Troy, at the time that the contracts are returned by him/her for execution, a Certificate of Insurance as well as the required endorsements. In lieu of required endorsements, if applicable, a copy of the policy sections where coverage is provided for additional insured and cancellation notice would be acceptable. Copies or certified copies of all policies mentioned above all shall be furnished, if so requested.

If any of the applicable coverages expire during the term of this contract, the Contractor shall deliver renewal certificates and endorsements to the City of Troy at least ten (10) days prior to the expiration date.

COMPANY NAME: _____

Forte Fitness Inc

SIGNATURE PAGE

PRICES:

Prices shall remain firm for 60 days or bid award, whichever comes first, except the successful bidder(s) whose prices shall remain firm through equipment delivery, trade-in pick-up, and final acceptance as operational in accordance with specifications.

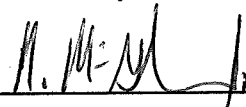
SIGNATURE OF AUTHORIZED COMPANY REPRESENTATIVE: 

NOTE:

The undersigned has checked carefully the bid figures and understands that he/she shall be responsible for any error or omission in this bid offer and is in receipt of all addenda as issued.

TAX ID#: 47-2566149

COMPANY NAME: Forte Fitness Inc

ADDRESS 7965 Ida Center Rd CITY Ida STATE Mi ZIP 49140

PHONE NUMBER 734-274-0010 FAX NUMBER N/A

REPRESENTATIVE'S NAME Norm McGlinnen

SIGNATURE OF AUTHORIZED COMPANY REPRESENTATIVE 
(Print)

PAYMENT TERMS: Net 30 WARRANTY: AS SPECIFIED

E-MAIL: NORM@T DELIVERY DATE: AS SPECIFIED

EXCEPTIONS:

Any exceptions, substitutions, deviations, etc., from the City specifications and this proposal must be stated below. The reason(s) for the exceptions, substitutions, and/or deviations are an integral part of this bid proposal offer:

We have quoted speed the Freemotion Incline TRAINERS
exactly as asked. we quoted STAR TRAC Commercial
onrelib Full three year parts and labor.

Check this box if your bid is not to be broken up by item and based on an all or none award.
* we will allow partial award *

ACKNOWLEDGEMENT:

I, Norm McGlinnen, certify that I have read the **Instructions to Bidders** (2 Pages) and that the bid proposal documents contained herein were obtained directly from the City's Purchasing Department or MITN website, www.mitn.info and is an official copy of the Authorized Version.

SIGNATURE OF AUTHORIZED COMPANY REPRESENTATIVE: 

IMPORTANT: All City of Troy purchases require a MATERIAL SAFETY DATA SHEET, where applicable, in compliance with the MIOSHA "Right to Know" Law. Please include a copy of any relevant MSDS at the time of bid submission.

U.S. FUNDS: All prices quoted are to be in U.S. Currency.
G:\Bid\FitnessEquipment ITB-COT 16-35.doc

1. The first part of the document discusses the importance of maintaining accurate records of all transactions. This is essential for ensuring the integrity of the financial statements and for providing a clear audit trail. The records should be kept up-to-date and should be easily accessible to all relevant parties.

2. The second part of the document outlines the procedures for handling discrepancies. It is important to identify any errors as soon as possible and to investigate the cause of the discrepancy. Once the cause has been identified, the necessary steps should be taken to correct the error and to prevent it from recurring.

3. The third part of the document discusses the importance of regular communication between all parties involved in the financial process. This includes the management, the accounting department, and the external auditors. Regular communication helps to ensure that everyone is aware of the current status of the financials and any potential issues.

4. The fourth part of the document outlines the requirements for the financial statements. These statements should be prepared in accordance with the relevant accounting standards and should be reviewed and approved by the management. The statements should be clear, concise, and easy to understand.

5. The fifth part of the document discusses the importance of maintaining a strong internal control system. This system should be designed to prevent and detect errors and fraud. It should be regularly reviewed and updated to reflect changes in the business environment.

6. The sixth part of the document outlines the procedures for handling tax matters. It is important to ensure that all tax obligations are met and that the company is taking full advantage of any available tax incentives. The tax department should work closely with the accounting department to ensure that the financials are accurate and that the tax returns are prepared correctly.

7. The seventh part of the document discusses the importance of maintaining a strong relationship with the external auditors. The auditors play a crucial role in ensuring the integrity of the financial statements and in providing an independent opinion on the company's financial performance. It is important to communicate openly and honestly with the auditors and to address any concerns they may have.

8. The eighth part of the document outlines the requirements for the annual financial statements. These statements should be prepared in accordance with the relevant accounting standards and should be reviewed and approved by the management. The statements should be clear, concise, and easy to understand.



**BID SPECIFICATIONS
PHYSICAL FITNESS EQUIPMENT**

GENERAL:

The Troy Community Center, located at 3179 Livernois, Troy, Michigan, 48083, is seeking to purchase and have installed eighteen (18) pieces of new Commercial Grade Physical Fitness Equipment for the Fitness Room. The fitness equipment bid must meet all requirements as specified. Brian Goul, Assistant Recreation Director is the contact for this project. (No substitutions will be allowed). All equipment is to be F.O.B. delivered freight paid with inside delivery to this location.

NEW EQUIPMENT TO PURCHASE: (18)

- 2 each – PreCor Vitality Multi-Press CO24ES
- 2 each – PreCor Vitality Leg Extension/ Leg Curl CO27ES
- 2 each – FreeMotion i11.9 Incline Treadmill
- 6 each – Matrix #T5x heavy duty treadmill
- 3 each – Matrix A3x heavy commercial Ascent Trainer
- 2 each – Matrix E3x heavy commercial Elliptical
- 1 each – Octane XR6000 XRide Seated Total Body Elliptical

EQUIPMENT TRADE-INS: (18)

- One (1) Lifefitness Hammer Strength Shoulder Press - 2002
- One (1) Lifefitness Hammer Strength Incline Press - 2002
- One (1) Lifefitness Hammer Strength Leg Curl – 2002
- One (1) Lifefitness Hammer Strength Leg Extension - 2002
- Eight (8) Matrix #T5x – 2013 Treadmills
- Three (3) Matrix A3x Ascent Trainers - 2013
- Two (2) Matrix E3x Elliptical - 2013
- One (1) Octane XR6000 XRide- 2012

Any prospective bidders may schedule an on-site appointment in order to inspect the existing equipment to be traded-in before bids are submitted. Please contact Brian Goul, Assistant Recreation Director at (248) 524-3484, between the hours of 8:00 am and 4:30 pm, Monday through Friday to make an appointment.

WARRANTY:

Minimum three (3) years warranty on the following:

- All parts and labor coverage
- All “wear items” (including running decks, belts, shrouds, grips, controls, etc)
- Free second day parts shipping.
- Free service calls (24 Hours) and technician travel at no additional cost to the City

AMach Lohr

DETAILED REQUIREMENTS:

1. The successful bidder(s) must provide a manufacturer approved 3-year warranty that stipulates if something breaks during "normal" use, the vendor will cover all labor and materials to ensure complete repair of the unit at no cost to the City of Troy.
2. The repair (vendor) facility must be within 100 miles of the City of Troy. The successful bidder(s) must be able to respond to a service request by phone within 24 hours and be able to be on site for service calls within 48 hours after initial service request. Any non-stock defective parts will be replaced at no cost to the City within three (3) calendar days from date of service call.
3. The successful bidder(s) must be an authorized dealer of the equipment that is being supplied.
4. All equipment must be new.
5. The successful bidder(s) must install the equipment.
6. The successful bidder(s) must train the Recreation Staff in the proper use and everyday maintenance of the equipment.
7. Service and warranty work cannot be subcontracted. The successful bidder(s) must be able to service and repair the equipment bid with in-house personnel.



City of Troy –

Forte Fitness has submitted a bid for fitness equipment for the recreation center. We included equipment from True Fitness, Core Health and Fitness and Freemotion Fitness. All brands with a long track record in commercial facilities.

The equipment specified meets what you requested or is an exact match, as in the Freemotion Incline Trainer. Warranties also meet the required three years parts and labor, Forte Fitness would like to include a free preventative maintenance program once a year for three years as part of our bid package.

I have included product info, but please direct any questions to me at 734-274-0010 or norm@fortefitusa.com

Respectfully,

A handwritten signature in black ink, appearing to read "M. McGlennen".

Norm McGlennen



i11.9 INCLINE TRAINER

DOMESTIC › FMTK74810

INTERNATIONAL › FMTK74810-INT

DOMESTIC TV › FMTV74810

INTERNATIONAL TV › FMTV74810-INT

FEATURES & BENEFITS

10" FULL-COLOR TOUCH SCREEN WITH BROWSER POWERED BY ANDROID™ › Browse the web* during any workout! With the built-in 10" full-color touch screen and browser Powered by Android™, every FreeMotion® Cardio machine delivers the ultimate motivation to your gym members. Now, they can check the news, read email, watch sports highlights, get on Facebook® and more! Plus, with wireless connectivity and a USB connection, console software is upgradable for the life of the product.

IFIT LIVE™ TECHNOLOGY BUILT-IN › Get smarter workouts and faster results with iFit Live™ Technology. Featuring workouts Powered by Google Maps™, training with Jillian Michaels and personalized, goal-specific programs, this wireless technology is the ultimate workout experience! Speed, incline and decline controls automatically adjust to match terrain and maximize results. Now, users can customize their own fitness program, receive automatic workout downloads and manage their profile online.

INCLINE AND DECLINE TRAINING › With up to 30% incline, users will recruit more muscle on the i11.9, targeting their quads and glutes. And, to perfect cadence and strengthen their legs for the downhill segments of the next marathon or 10K, the 3% decline adds variety and realistic training to any program. The lift motor, specifically designed for the Incline Trainer, delivers 1500 lbs. of lift force for consistent deck movement and stabilization.

PRODUCT SPECIFICATIONS

New Workout Features	iFit Live™ Technology Built-In, 10" Touch Screen with Browser Powered by Android™
Dimensions (LWH)	79.50" x 37.25" x72.25"
Weight Capacity	400 lbs. (181 kgs)
Warranty	7-Year Frame & Motor, 2-Year Parts, 1-Year Console, Belt, and Labor
Built-In Wireless Controls	Cardio Theater, Broadcastvision™ Entertainment, MYE™ Entertainment, CardioVision, Fantaay™, FreeVision™ HDTV

*

* Forste Fitness Included three year parts + labor warranty

Freemotion
877.363.8449 › www.freemotionfitness.com

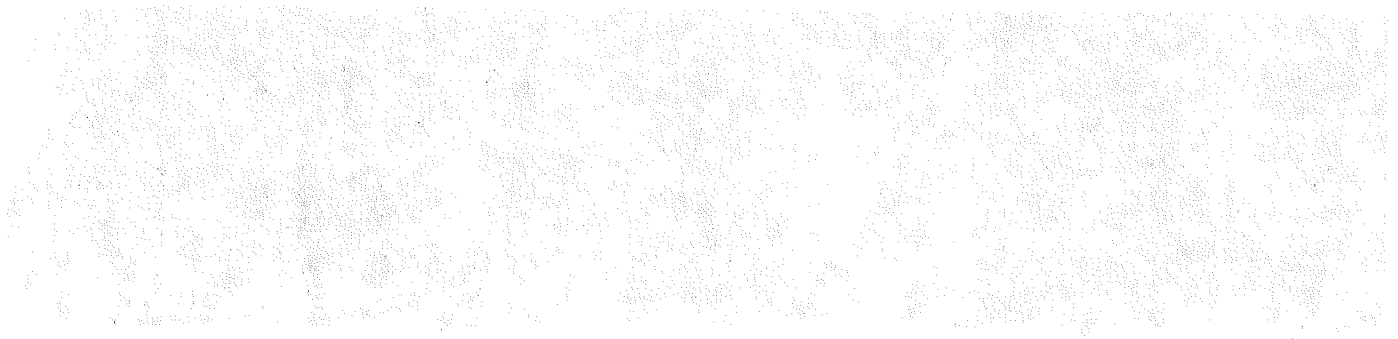

1. Introduction

The purpose of this study is to investigate the effects of various factors on the performance of a system. The study is organized as follows: Section 2 describes the methodology used in the study. Section 3 presents the results of the study. Section 4 discusses the implications of the findings. Section 5 concludes the study.

The methodology used in this study is a combination of experimental and analytical methods. The experimental part of the study involves the use of a test system to measure the performance of the system under various conditions. The analytical part of the study involves the use of mathematical models to analyze the results of the experiments.

The results of the study show that the performance of the system is significantly affected by the various factors investigated. The findings of the study have important implications for the design and operation of the system.

The implications of the findings of the study are discussed in Section 4. The study concludes that the performance of the system can be improved by optimizing the various factors investigated.

The study is limited to the factors investigated and the results may not be applicable to other systems. Further research is needed to investigate the effects of other factors on the performance of the system.

The authors would like to thank the following people for their assistance in the study: [Name], [Name], and [Name].

The authors would like to thank the following organizations for their support of the study: [Organization], [Organization], and [Organization].

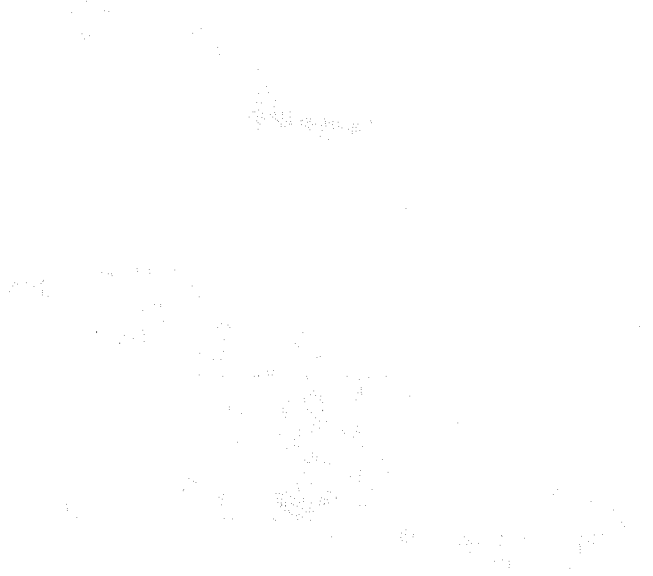

10



17" FREEVISION™ HDTV – OPTIONAL UPGRADE › Add motivation to any workout with this optional upgrade. A wide viewing angle and dynamic contrast and color saturation combine for a beautiful picture. Individual product TVs deliver a more personalized, entertaining workout for every user. The FreeMotion® Cardio consoles feature integrated TV controls and are prewired for a fast and easy upgrade.

DIRECT REAR VELOCITY SYSTEM › This self-cooling, 5.0 CHP high-torque, brushless AC speed control motor is positioned at the back of the machine for a smoother running surface and easier maintenance.

INCLINE AND DECLINE TRAINING › With up to 30% incline, users will recruit more muscle on the i11.9, targeting their quads and glutes. And, to perfect cadence and strengthen their legs for the downhill segments of the next marathon or 10K, the 3% decline adds variety and realistic training to any program. The lift motor, specifically designed for the Incline Trainer, delivers 1500 lbs. of lift force for consistent deck movement and stabilization.

9 BUILT-IN WORKOUTS › Preset workouts deliver competition, weight-loss, map and HD video workouts to help users of all levels reach their goals. Quick console controls make it easy to get started!

EXTRA-LONG, CUSHIONED DECK › Featuring a commercial, double-layered, double-sided deck, the i11.9 Incline Trainer is built to last. Users can stretch out their stride with the 22" x 60" 2-ply treadbelt and feel the incredible joint protection with built-in isolator cushioning.

QUICK WORKOUT CONTROLS › Quickly adjust speed, incline and decline with these convenient console controls. Members can personalize their workout with the touch of a button instead of scrolling through settings found on other equipment.

BUILT-IN WIRELESS CONTROLS › Connect each machine wirelessly to Cardio Theater, Broadcastvision™ Entertainment, MYE™ Entertainment, CardioVision and Fantaay™ audio broadcasting. Built-in compatibility eliminates the need for other hardware or wires.

ENTERTAINMENT CHARGING STATION › Charge an iPod®**, MP3 Player or phone during any workout with this convenient charging station. A headphone jack allows the user to listen to their music and Jillian Michaels during an iFit Live™ Workout.



OTHER FEATURES

- › 0 – 12 MPH 1-Step™ Speed Control
- › 0 – 30% 1-Step™ Incline Control
- › -3 – 0% 1-Step™ Decline Control
- › Set-a-Goal Workout Center
- › (2) 4" AutoBreeze™ Workout Fans
- › 3.5" Crowned, Spin-Balanced Rollers
- › Dual-Grip Heart Rate Monitor
- › Compatible with Polar® Wireless Chest Strap***
- › 17" FreeVision™ HDTV – Optional Upgrade

*Web browsing feature can be disabled.

**iPod is a trademark of Apple, Inc., registered in the US and other countries.

iPod® not included.

***Wireless chest pulse strap not included.

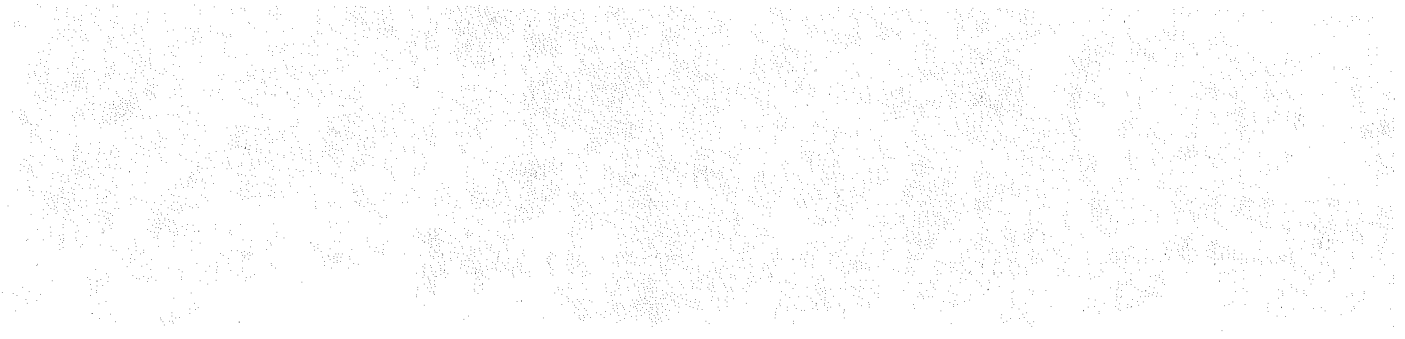

FITNESS LINE

Row and Single Stations

FS-50

**LEG EXTENSION /
 LEG CURL**



- 5 position back pad and 6 position leg curl thigh pad to accommodate a wide range of users.
- 5 starting positions for both extensions and curls allow users to choose the range of motion best suited to their individual needs.
- Self adjusting ankle pad eliminates the need for an adjustment while providing proper support throughout the entire range of motion.
- Large easy to read instruction labels with QR codes linked to instructional online videos.

Weight Stack Options	170 lbs. (77 kg)	250 lbs. (113 kg)
Machine Weight	474 lbs. (215 kg)	554 lbs. (251 kg)

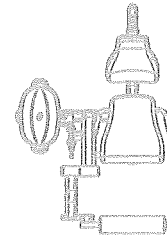
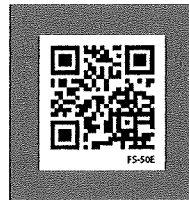

Dimensions
 W: 43" (109 cm)
 L: 63" (160 cm)
 H: 57" (145 cm)

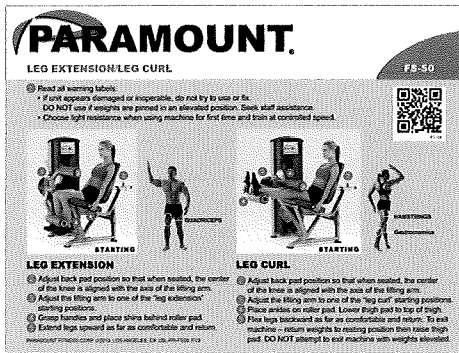

FRAME PAINT COLOR:
 SILVER
 Standard upholstery color Black.



101

102

103

104

105

106

107

108

109



110

111

112

113

114

115

116

FITNESS LINE

Dual and Single Stations

FS-54

MULTI-PRESS

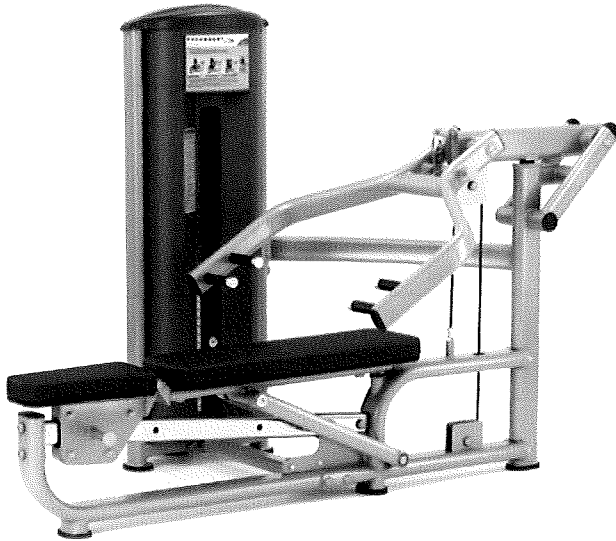

- 4 position seat and back pad assembly easily adjusts for Supine, 25 and 45 degree Incline, and Shoulder Press movements.
- 5 position arm allows users to choose the range of motion best suited to their individual needs.
- Dual hand grips accommodate a wide range of users and allow exercise variation.
- Large easy to read instruction labels with QR codes linked to instructional online videos.

Weight Stack Options	170 lbs. (77 kg)	250 lbs. (113 kg)
Machine Weight	501 lbs. (227 kg)	581 lbs. (264 kg)

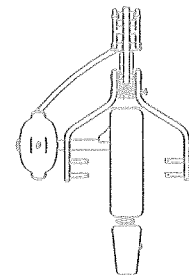
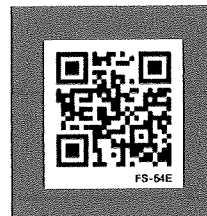

Dimensions
 W: 53" (135 cm)
 L: 82" (208 cm)
 H: 57" (145 cm)

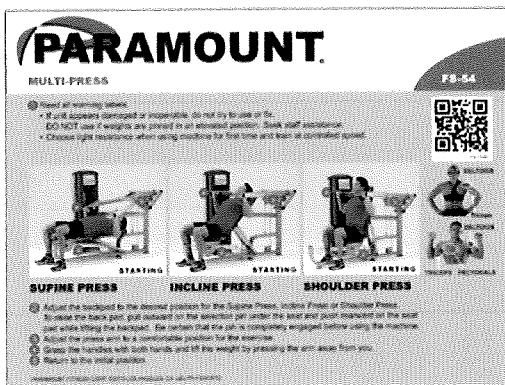

FRAME PAINT COLOR:
 SILVER
 Standard upholstery color Black.



1911



THE UNIVERSITY OF CHICAGO LIBRARY



Features

- › Choose from a variety of 10', 15' & LCD consoles.
- › Soft Trac[®] pedals provide ultimate shock-absorbing comfort throughout the entire workout
- › Efficient footprint and approachable, stable platform with minimal step-up height for easy access from all angles
- › User-friendly console and keypad feature a large service scrolling message window, user-specific workout programs, a dedicated heart rate display, Polar[®] telemetry and multiple cup and accessory holders
- › Star Trac's popular personal fans create a more rewarding workout
- › User weight capacity of 350 lbs (159 kg)

8-CT Cross Trainer

Elliptical training has become second only to treadmill training in facilities across the globe and it has become one of the most important cardio categories in the eyes of many clients. Finding the right motion, creating user-centric safety features and offering the industry's best entertainment solutions was paramount in our Cross Trainer design. The breakthrough begins with an ingenious rear approach open-step design that gives you the safest possible entry and exit on and off the product. The pedal placement design offers a best in class Q factor for enhanced biomechanics and our Soft Trac[®] pedals ensures maximum comfort throughout the training session. The result is a better, more effective and more efficient workout.

Console Options



PVS (for LCD & 10") 15" Embedded Touchscreen 10" Touchscreen LCD

When we set out to design our new console, our philosophy was simple: provide a flexible platform that connects expert partners to provide solutions for every customer for today and into the future. Introducing the new OpenHub family of Cardio Consoles. OpenHub™ is a smart, affordable, configurable solution available on Star Trac and StairMaster cardio equipment. The best part is, you add (and pay for) only what you want, when you want. The future of club connectivity is here. The future is OpenHub.

Specifications

Overall Weight	Length	Width	Height	Max User Weight
456lbs (207 kg)	76" (193 cm)	30" (76 cm)	72" (182 cm)	350lbs (159 kg)

SKU

- 9-6140-8CT-LCD
- 9-6140-8CT-15-ISDB-DMB
- 9-6140-8CT-10
- 9-6140-8CT-15-ATSC
- 9-6140-8CT-15-PAL

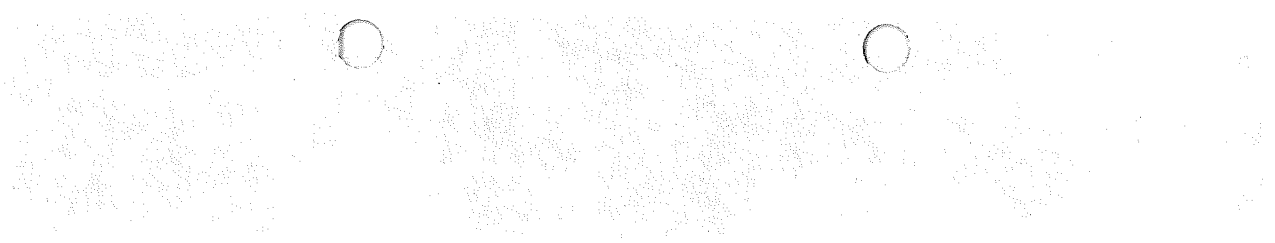

Faint, illegible text in the upper middle section of the page, appearing as a block of noise.

Faint, illegible text in the middle section of the page, appearing as a block of noise.

Faint, illegible text in the lower middle section of the page, appearing as a block of noise.

Faint, illegible text in the lower section of the page, appearing as a block of noise.

Faint, illegible text at the bottom of the page, appearing as a block of noise.



Features

- Choose from a variety of 10', 15' & LCD consoles.
- Pre-wired for 8 Series personal viewing screen entertainment system
- User-friendly console and keypad feature a large service scrolling message window, user-specific workout programs, a dedicated heart rate display, Polar® telemetry and multiple cup and accessory holders
- Soft Trac® triple cell cushioning system provides maximum shock absorption
- 5 HP AC motor
- Star Trac's popular personal fans create a more rewarding workout
- 21.5" (54.6 cm) wide belt
- 9" (22.8 cm) step-up height
- User weight capacity 500 lbs (227 kg)

8-TR Treadmill

Two decades of treadmill design leadership have positioned us for success with multiple models to meet the needs of every market segment. When you're looking for a full commercial treadmill experience with a budget in mind, the 8-TR is a great place to start. We've simplified the display but kept all the features that matter most to the end user. From the patented deck suspension system, to the popular personal fans, to the intuitive user interface, all the commercial features are on board. Combine these features with the safety elements designed into all Star Trac products and you have a winning design that meets the needs of the treadmill user.

Console Options

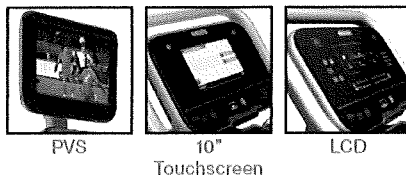

When we set out to design our new console, our philosophy was simple: provide a flexible platform that connects expert partners to provide solutions for every customer for today and into the future. Introducing the new OpenHub family of Cardio Consoles. OpenHub™ is a smart, affordable, configurable solution available on Star Trac and StairMaster cardio equipment. The best part is, you add (and pay for) only what you want, when you want. The future of club connectivity is here. The future is OpenHub.

Specifications

Overall Weight	Length	Width	Height	Max User Weight
576lbs (261 kg)	81" (206 cm)	32" (81 cm)	60" (152 cm)	500lbs (227 kg)

SKU

- 9-9191-8TR-110-LCD
- 9-9194-8TR-220CE-LCD
- 9-9192-8TR-220UL-LCD
- 9-9191-8TR-110-10
- 9-9194-8TR-220CE-10

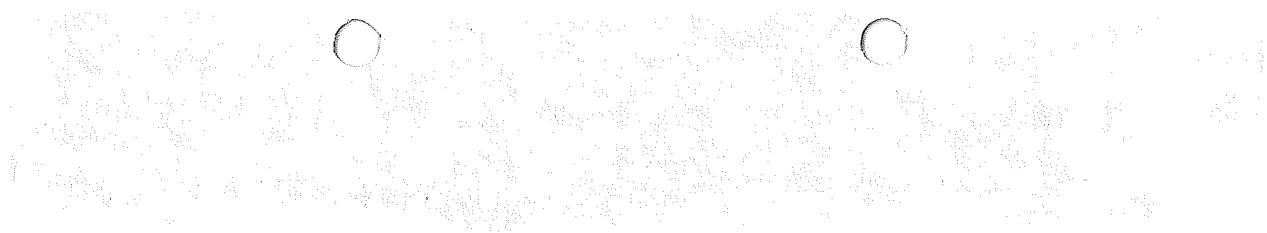

[Faint, illegible text, possibly bleed-through from the reverse side of the page]

[Faint, illegible text, possibly bleed-through from the reverse side of the page]

[Faint, illegible text, possibly bleed-through from the reverse side of the page]

[Faint, illegible text, possibly bleed-through from the reverse side of the page]



Legal Status of Bidder:

The Bidder shall fill out the appropriate form and strike out the other two:

Forte Fitness Inc

A **corporation** duly organized and doing business under the laws of the State of Michigan
for whom Norm McGlinnnew, bearing the office title of VP,
whose signature is affixed to this proposal, is duly authorized to execute contracts.

A **partnership**, all members of which, with addresses, is:

Rod Ratno Pres

7965 Ida Center Rd

Ida Mi 48146

Norm McGlinnnew VP

2110 Churchill Dr

Ann Arbor Mi 48103

48103

AN **INDIVIDUAL**, WHOSE SIGNATURE IS AFFIXED TO THE PROPOSAL:

M. McGlinnnew

10-13-16

1000
1000

1000

1000

1000

1000

1000

1000

1000

1000

1000

1000

1000

1000

1000

1000

1000



CITY OF TROY
OAKLAND COUNTY, MICHIGAN
NON-COLLUSION AFFIDAVIT

TO WHOM IT MAY CONCERN:

NORMAN E. MCGILINNON JR., being duly sworn deposed, says that he/she
(Print Full Name)

is Vice President. The party making the foregoing proposal or bid,
(State Official Capacity in Firm)

that such bid is genuine and not collusion or sham; that said bidder has not colluded, conspired, connived, or agree, directly or indirectly, with any bidder or person, to put in a sham bid or to refrain from bidding and has not in any manner directly or indirectly sought by agreement or collusion, or communication or conference, with any person to fix the bid price or affiant or any other bidder, or to fix any overhead, profit, or cost element of said bid price, or that of any other bidder, or to secure the advantage against the City of Troy or any person interested in the proposed contract; and that all statements contained in said proposal or bid are true.

SIGNATURE OF PERSON SUBMITTING BID

NOTARY'S SIGNATURE

Subscribed and sworn to before me this 14th day of
October, 2016 in and for WASHTENAW County.

My commission expires:
10-17-2018

MIMOZA RAMAXHIKU
STATE OF MICHIGAN
NOTARY PUBLIC
COUNTY OF WASHTENAW
MY COMMISSION EXPIRES OCT. 17, 18
ACTING IN THE COUNTY WASHTENAW

1950

1950

1950

1950

1950

1950

1950

1950

1950

1950

1950



**CERTIFICATION REGARDING
DEBARMENT, SUSPENSION, AND OTHER RESPONSIBILITY MATTERS**

The prospective participant certifies, to the best of its knowledge and belief, that it and its principals:

1. Are not presently debarred, suspended, proposed for debarment, declared ineligible, or voluntarily excluded from participation in transactions under any non-procurement programs by any federal, state or local agency.
2. Have not, within the three year period preceding, had one or more public transactions (federal, state, or local) terminated for cause or default; and
3. Are not presently indicted or otherwise criminally or civilly charged by a government entity (federal, state, or local) and have not, within the three year period preceding the proposal, been convicted of or had a civil judgment rendered against it:
 - a. For the commission of fraud or a criminal offense in connection with obtaining, attempting to obtain, or performing a public transaction (federal, state, or local), or a procurement contract under such a public transaction;
 - b. For the violation of federal, or state antitrust statutes, including those proscribing price fixing between competitors, the allocation of customers between competitors, or bid rigging; or
 - c. For the commission of embezzlement, theft, forgery, bribery, falsification or destruction of records, making false statements, or receiving stolen property.

I understand that a false statement on this certification may be grounds for the rejection of this proposal or the termination of the award. In addition, the general grant of this authority exists within the City's Charter, Chapter 12, Section 12.2- Contracts.

I am able to certify to the above statements.

Fozte Fitness Inc

Name of Agency/Company/Firm (Please Print)

Norm McBlinnen VP

Name and title of authorized representative (Please Print)

Signature of authorized representative

Date

10-13-16

I am unable to certify to the above statements. Attached is my explanation.

The first part of the document discusses the importance of maintaining accurate records of all transactions. It emphasizes that proper record-keeping is essential for the integrity of the financial system and for the ability to detect and prevent fraud. The text also mentions the need for regular audits and the role of independent auditors in ensuring the reliability of the financial statements.

In addition, the document highlights the significance of transparency and accountability in financial reporting. It states that stakeholders, including investors and the public, have a right to know how their money is being managed. This requires the provision of clear, concise, and timely information about the organization's financial performance and the underlying transactions that have led to that performance.

The text further discusses the challenges faced by organizations in implementing robust financial controls. It notes that the complexity of modern business operations, coupled with the rapid pace of technological change, can make it difficult to keep up with the latest best practices. However, it stresses that organizations must remain committed to continuous improvement and seek out innovative solutions to address these challenges.

Finally, the document concludes by reiterating the central theme of the importance of ethical conduct in financial reporting. It asserts that honesty and integrity are not just moral imperatives but also practical necessities for the long-term success of any organization. By adhering to high ethical standards, organizations can build trust with their stakeholders and ensure the sustainability of their operations.

The document also touches upon the role of regulatory bodies in overseeing financial reporting. It explains that these organizations are responsible for setting and enforcing the rules that govern how financial information is presented. This oversight is crucial for maintaining a level playing field and for protecting the interests of investors and other market participants.

In summary, the document provides a comprehensive overview of the key principles and practices that underpin effective financial reporting. It serves as a guide for organizations seeking to enhance their financial transparency and accountability, and for regulators and auditors looking to ensure the highest standards of financial integrity.

The document also includes a section on the importance of communication in financial reporting. It notes that clear and consistent communication is essential for ensuring that financial information is understood and used correctly. This involves not only the preparation of high-quality financial statements but also the effective dissemination of that information to all relevant stakeholders.

Overall, the document is a valuable resource for anyone involved in financial reporting. It provides a clear and concise overview of the key issues and challenges in this field, and offers practical advice on how to address these issues effectively. By following the principles and practices outlined in this document, organizations can ensure the integrity and reliability of their financial reporting, and thereby build trust and confidence with their stakeholders.

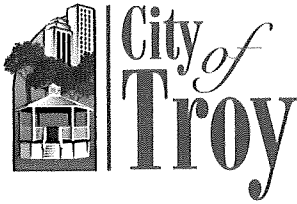

**VENDOR CERTIFICATION
THAT IT IS NOT AN
"IRAN LINKED BUSINESS"**

Pursuant to Michigan law, (the Iran Economic Sanctions Act, 2012 PA 517, MCL 129.311 et seq.), before accepting any bid or proposal, or entering into any contract for goods or services with any prospective Vendor, the Vendor must first certify that it is not an "IRAN LINKED BUSINESS", as defined by law.

Vendor	
Legal Name	Forte Fitness Inc
Street Address	7965 Ida Center Rd
City	Ida
State, Zip	Ida MI. 48140
Corporate I.D. Number/State	Duns# 080213731
Taxpayer I.D. #	47-2566149

The undersigned, with: 1.) full knowledge of all of Vendors business activities, 2.) full knowledge of the requirements and possible penalties under the law MCL 129.311 et seq. and 3.) the full and complete authority to make this certification on behalf of the Vendor, by his/her signature below, certifies that: the Vendor is NOT an "IRAN LINKED BUSINESS" as require by MCL 129.311 et seq., and as such that Vendor is legally eligible to submit a bid and be considered for a possible contract to supply goods and/or services to the City of Troy.

Signature of Vendor's Authorized Agent:

M. M. J. 10/13/16

Printed Name of Vendor's Authorized Agent:

Norm McBlinnen

Witness Signature:

Heather Horne

Printed Name of Witness:

HEATHER HORNE



**STATEMENT OF NO BID
CITY OF TROY**

BID NUMBER: ITB-COT 16-35
TITLE: PHYSICAL FITNESS EQUIPMENT

Please Send or Fax To:
City of Troy Purchasing Department
500 W. Big Beaver Rd.
Troy, MI 48084

*We intend to bid
This*

FAX NUMBER: (248) 619-7608

We, the undersigned, have declined to bid on the subject bid for the following reasons:

Check All That Apply	Reason
<input type="checkbox"/>	Our company does not handle the type of product / service
<input type="checkbox"/>	We cannot meet the specifications nor provide an approved alternate – please explain below
<input type="checkbox"/>	Our company is not interested in bidding at this time
<input type="checkbox"/>	Job is too small
<input type="checkbox"/>	Job is too large
<input type="checkbox"/>	Cannot be competitive
<input type="checkbox"/>	Liability Issues such as insurance, bonding, indemnification, hold harmless
<input type="checkbox"/>	Insufficient time to respond – please explain below
<input type="checkbox"/>	Our company's schedule would not permit performance of the specifications
<input type="checkbox"/>	Other – describe below

REMARKS: *We intend to bid*

COMPANY INFORMATION:

COMPANY NAME: Forte Fitness
SIGNATURE OF AUTHORIZED COMPANY REPRESENTATIVE: *[Signature]*
TITLE: VP
COMPANY: 7965 Ida Center Rd
ADDRESS: Ida MI 48140
FAX NUMBER: N/A TELEPHONE NUMBER: 734-274-0010

IMPORTANT NOTE: To qualify as a respondent to the bid, the vendor must submit a bid or return this completed form.

VENDOR REGISTRATION: The City of Troy uses the MITN website for vendor registration, bid and tabulation posting, award information and other processes. Final bid results will be posted on the MITN website after award. Please register to see results - - www.mitn.info.



[Faint, illegible text covering the majority of the page, likely bleed-through from the reverse side.]



CERTIFICATE OF LIABILITY INSURANCE

DATE (MM/DD/YYYY)
3/20/2015

THIS CERTIFICATE IS ISSUED AS A MATTER OF INFORMATION ONLY AND CONFERS NO RIGHTS UPON THE CERTIFICATE HOLDER. THIS CERTIFICATE DOES NOT AFFIRMATIVELY OR NEGATIVELY AMEND, EXTEND OR ALTER THE COVERAGE AFFORDED BY THE POLICIES BELOW. THIS CERTIFICATE OF INSURANCE DOES NOT CONSTITUTE A CONTRACT BETWEEN THE ISSUING INSURER(S), AUTHORIZED REPRESENTATIVE OR PRODUCER, AND THE CERTIFICATE HOLDER.

IMPORTANT: If the certificate holder is an ADDITIONAL INSURED, the policy(ies) must be endorsed. If SUBROGATION IS WAIVED, subject to the terms and conditions of the policy, certain policies may require an endorsement. A statement on this certificate does not confer rights to the certificate holder in lieu of such endorsement(s).

PRODUCER UNITED INSURANCE SERVICE 761 S. Telegraph Rd Monroe MI 48161		CONTACT NAME: Carrie Beaudrie PHONE (A/C No. Ext): (734) 457-2204 FAX (A/C. No): (419) 448-5041 E-MAIL ADDRESS: cbeaudrie@uisprotect.com	
INSURED Forte Fitness Inc 7965 Ida Center Rd Ida MI 48140		INSURER(S) AFFORDING COVERAGE INSURER A: CSU Producer Resources, Inc. INSURER B: Accident Fund Insurance Company INSURER C: INSURER D: INSURER E: INSURER F:	

COVERAGES **CERTIFICATE NUMBER:** CL1511408782 **REVISION NUMBER:**

THIS IS TO CERTIFY THAT THE POLICIES OF INSURANCE LISTED BELOW HAVE BEEN ISSUED TO THE INSURED NAMED ABOVE FOR THE POLICY PERIOD INDICATED. NOTWITHSTANDING ANY REQUIREMENT, TERM OR CONDITION OF ANY CONTRACT OR OTHER DOCUMENT WITH RESPECT TO WHICH THIS CERTIFICATE MAY BE ISSUED OR MAY PERTAIN, THE INSURANCE AFFORDED BY THE POLICIES DESCRIBED HEREIN IS SUBJECT TO ALL THE TERMS, EXCLUSIONS AND CONDITIONS OF SUCH POLICIES. LIMITS SHOWN MAY HAVE BEEN REDUCED BY PAID CLAIMS.

INSR LTR	TYPE OF INSURANCE	ADDL INSR	SUBR WVD	POLICY NUMBER	POLICY EFF (MM/DD/YYYY)	POLICY EXP (MM/DD/YYYY)	LIMITS
A	GENERAL LIABILITY <input checked="" type="checkbox"/> COMMERCIAL GENERAL LIABILITY <input type="checkbox"/> CLAIMS-MADE <input checked="" type="checkbox"/> OCCUR GEN'L AGGREGATE LIMIT APPLIES PER: <input checked="" type="checkbox"/> POLICY <input type="checkbox"/> PRO. JECT <input type="checkbox"/> LOC			CSU0066199	1/13/2015	1/13/2016	EACH OCCURRENCE \$ 1,000,000 DAMAGE TO RENTED PREMISES (Ea occurrence) \$ 50,000 MED EXP (Any one person) \$ 10,000 PERSONAL & ADV INJURY \$ 1,000,000 GENERAL AGGREGATE \$ 2,000,000 PRODUCTS - COM/OP AGG \$ 2,000,000
	AUTOMOBILE LIABILITY <input type="checkbox"/> ANY AUTO <input checked="" type="checkbox"/> ALL OWNED AUTOS <input type="checkbox"/> SCHEDULED AUTOS <input checked="" type="checkbox"/> HIRED AUTOS <input checked="" type="checkbox"/> NON-OWNED AUTOS			CSU0066199	1/13/2015	1/13/2016	COMBINED SINGLE LIMIT (Ea accident) \$ 1,000,000 BODILY INJURY (Per person) \$ BODILY INJURY (Per accident) \$ PROPERTY DAMAGE (Per accident) \$
A	<input checked="" type="checkbox"/> UMBRELLA LIAB <input checked="" type="checkbox"/> OCCUR <input type="checkbox"/> EXCESS LIAB <input type="checkbox"/> CLAIMS-MADE <input type="checkbox"/> DED <input checked="" type="checkbox"/> RETENTION \$ 0			CSU0066200	1/13/2015	1/13/2016	EACH OCCURRENCE \$ 1,000,000 AGGREGATE \$
B	WORKERS COMPENSATION AND EMPLOYERS' LIABILITY ANY PROPRIETOR/PARTNER/EXECUTIVE OFFICER/MEMBER EXCLUDED? (Mandatory in NH) <input type="checkbox"/> Y/N If yes, describe under DESCRIPTION OF OPERATIONS below		N/A	WCV6107777	1/13/2015	1/13/2016	<input checked="" type="checkbox"/> WC STATUTORY LIMITS <input type="checkbox"/> OTHER E.L. EACH ACCIDENT \$ 1,000,000 E.L. DISEASE - EA EMPLOYEE \$ 1,000,000 E.L. DISEASE - POLICY LIMIT \$ 1,000,000

DESCRIPTION OF OPERATIONS / LOCATIONS / VEHICLES (Attach ACORD 101, Additional Remarks Schedule, if more space is required)

CERTIFICATE HOLDER **CANCELLATION**

CERTIFICATE HOLDER 	SHOULD ANY OF THE ABOVE DESCRIBED POLICIES BE CANCELLED BEFORE THE EXPIRATION DATE THEREOF, NOTICE WILL BE DELIVERED IN ACCORDANCE WITH THE POLICY PROVISIONS.
	AUTHORIZED REPRESENTATIVE Jeremy Hosler/CLB



[The text in this document is extremely faint and illegible. It appears to be a multi-page document with several columns of text, possibly a ledger or a report. The content is mostly lost to the quality of the scan.]

C:

C:



**CITY OF TROY
BID PROPOSAL**

**ITB-COT 16-35
Page 1 of 6**

The undersigned proposes to purchase and install **NEW PHYSICAL FITNESS EQUIPMENT FOR THE TROY COMMUNITY CENTER LESS TRADE-INS**, in accordance with the specifications, which are to be considered an integral part of this proposal, at the following prices:

COMPANY NAME: All Pro Exercise

PROPOSAL: TO PURCHASE AND INSTALL EIGHTEEN (18) PIECES OF PHYSICAL FITNESS EQUIPMENT FOR THE TROY COMMUNITY CENTER FITNESS ROOM LESS TRADE-INS IN ACCORDANCE WITH THE ATTACHED SPECIFICATIONS AS FOLLOWS:

The undersigned, as bidder, declares that he/she has examined the specifications, including related documents. Being familiar with the conditions in the City of Troy and the type of work required, the bidder hereby proposes to furnish all labor, materials, equipment and supplies, to provide the services specified in the bid proposal documents, at the prices stated below. These prices are to cover all expenses incurred in performing the work required:

		EQUIPMENT TO PURCHASE (1 for 1 trade-in exchange)		Exact Total Cost
Quantity	Description (No Substitutions)	Unit Cost (Each)	Estimated Total Cost	
1	Two (2)	PreCor Vitality Multi-Press CO24ES	\$ 2195 ⁰⁰ /lea	\$ 4390 ⁰⁰
2	Two (2)	PreCor Vitality Leg Extension/Leg Curl CO27ES	\$ 2195 ⁰⁰ /lea	\$ 4390 ⁰⁰
3	Two (2)	FreeMotion i11.9 Incline Treadmill	\$ 4595 ⁰⁰ /lea	\$ 9190 ⁰⁰
4	Six (6)	Matrix #T5x-2016, heavy commercial treadmill	\$ 4795 ⁰⁰ /lea	\$ 28,770 ⁰⁰
5	Three (3)	Matrix A3x heavy commercial Ascent Trainer	\$ 4895 ⁰⁰ /lea	\$ 14,685 ⁰⁰
6	Two (2)	Matrix E3x heavy commercial Elliptical	\$ 3595 ⁰⁰ /lea	\$ 7,190 ⁰⁰
7	One (1)	Octane XR6000 X Ride Seated Total Body Elliptical	\$ 3695 ⁰⁰ /lea	\$ 3,695 ⁰⁰
8	TRADE-INS			
Quantity	Description	Estimated Trade-In Amount (Each)	Estimated Trade-In Amount Total	Exact
One (1)	Lifefitness Hammer Strength Shoulder Press - 2002	(\$ 225 ⁰⁰)	(\$ 225 ⁰⁰)	
One (1)	Lifefitness Hammer Strength Incline Press-2002	(\$ 225 ⁰⁰)	(\$ 225 ⁰⁰)	
One (1)	Lifefitness Hammer Strength Leg Curl - 2002	(\$ 225 ⁰⁰)	(\$ 225 ⁰⁰)	
One (1)	Lifefitness Hammer Strength Leg Extension-2002	225 ⁰⁰	225 ⁰⁰	
Eight (8)	Matrix #T5x - 2013 Treadmills	(\$ 700 -)x8= 5600 ⁰⁰	(\$ 5600 ⁰⁰)	
Three (3)	Matrix A3x Ascent Trainers - 2013	(\$ 600 -)x3= 1800 ⁰⁰	(\$ 1800 ⁰⁰)	
Two (2)	Matrix E3x Elliptical - 2013	(\$ 500 -)x2= 1000 ⁰⁰	(\$ 1000 ⁰⁰)	
One (1)	Octane XR6000 XRide - 2012	(\$ 600 -)x1= 600 ⁰⁰	(\$ 600 ⁰⁰)	
	DEDUCT:	(\$)	(\$ 9000 ⁰⁰)	
		Estimated Net Total Cost		\$ 9,900 ⁰⁰



The first part of the document discusses the importance of maintaining accurate records of all transactions. This includes not only sales and purchases but also the various expenses incurred in the course of business. It is essential to ensure that every dollar is accounted for and that the books are balanced at all times.

In addition to the financial records, it is also important to keep track of the physical assets of the business. This includes inventory, equipment, and real estate. Regular audits should be conducted to ensure that these assets are properly valued and that there is no loss or theft.

The second part of the document deals with the legal aspects of business operations. This includes understanding the various laws and regulations that apply to the business, such as those related to contracts, taxes, and labor. It is important to consult with legal counsel to ensure that the business is operating in full compliance with the law.

Finally, the document discusses the importance of effective communication and management. This includes the need to establish clear lines of communication and to ensure that all employees are properly trained and supervised. It is also important to have a system in place for handling customer complaints and resolving disputes.

In conclusion, the document emphasizes the need for a comprehensive and systematic approach to business management. This includes not only the financial and legal aspects but also the human and operational aspects. By following the guidelines outlined in this document, business owners can ensure that their operations are efficient, profitable, and compliant with the law.

The following table provides a summary of the key points discussed in the document. It is intended to serve as a quick reference for business owners and managers.

It is important to note that this document is not intended to provide legal or financial advice. It is intended to provide general information and guidance. For more detailed information, please consult with a qualified professional.

The document is organized into several sections, each dealing with a different aspect of business management. The sections are as follows:

1. Financial Management
 2. Legal Compliance
 3. Human Resources
 4. Operations and Management

IMPORTANT:

In order to be considered for an award and your company is bidding on any items 1 – 7; it is required that items listed under Item #8 as a Trade-in have a corresponding purchase price.

The City intends to award this bid on a (1) one for (1) one exchange. For every piece of equipment purchased by the City from a vendor, that vendor will be required to purchase one (1) trade-in from the equipment listed under Item #8. The decision as to which trade-ins will be awarded to what vendor will be made in the City of Troy's best interest and will be final.

NOTE: Include all delivery costs, handling, packaging, and service charges.

UNIT PRICES:

Unit prices prevail. The City of Troy Purchasing Department will correct all mathematical errors.

DESCRIPTIVE LITERATURE:

Please attach descriptive or pertinent literature relevant to your company's bid proposal at the time of bid submission. It is attached and marked ALTERNATES for your identification.

ADDITIONAL INFORMATION:

For questions about the specifications, please contact Mr. Brian Goul, Assistant Recreation Director at (248) 524-3484, between the hours of 8:00 AM and 4:30 PM, Monday through Friday.

DELIVERY:

All items are to be F.O.B. delivered, freight paid with inside delivery, to the Troy Community Center, 3179 Livernois Rd, Troy, MI 48083, ATTN: Brian Goul.

DELIVERY SCHEDULE:

It is preferred all equipment be delivered and installed at the Troy Community Center by **December 15, 2016**. It will be the successful bidder's responsibility to work with the department representative to establish an acceptable delivery and installation schedule. Installation shall be within two (2) business days after receipt of the equipment at the City's location. The equipment should not be delivered to the City's site unless the equipment is to be installed and made ready for use within the above parameters. The City of Troy is the only party to this contract that may authorize amendment to this schedule.

- Our Company can meet this delivery and installation schedule
- Our company cannot meet this delivery and installation schedule but offers: _____

DOWN-PAYMENTS OR PREPAYMENTS:

Any bid proposal submitted which requires a down-payment or prepayment prior to delivery and full acceptance of the item(s) as being in conformance with specifications will not be considered for award.

AWARD:

The evaluation and award of this bid shall be a combination of factors, including but not limited to: cost, professional competence, equipment as specified, warranties, and the correlation of the proposal submitted to the needs of the City of Troy.

The City of Troy reserves the right to award this bid to the lowest responsible bidder(s) meeting specifications for the purchase of Physical Fitness Equipment when combined with an equal number of equipment pieces from the trade-in list under Item #7, or to combine the items in whatever manner is deemed to be in the City of Troy's best interest; to reject low bids which have major deviations from the specifications; to accept a higher bid which has only minor deviations; to accept or reject the trade-in offers.

COMPANY NAME: All PRO Exercise

1. The first part of the document discusses the importance of maintaining accurate records of all transactions and activities. It emphasizes that this is crucial for ensuring transparency and accountability in the organization's operations.

2. The second part of the document outlines the various methods and tools used to collect and analyze data. It highlights the need for consistent and reliable data collection processes to support effective decision-making.

3. The third part of the document focuses on the role of technology in data management and analysis. It discusses how modern software solutions can streamline data collection, storage, and reporting, thereby improving efficiency and accuracy.

4. The fourth part of the document addresses the challenges associated with data management, such as data quality, security, and integration. It provides strategies to overcome these challenges and ensure that the data remains reliable and accessible.

5. The fifth part of the document discusses the importance of data governance and the role of various stakeholders in ensuring that data is used responsibly and in compliance with relevant regulations and standards.

6. The sixth part of the document explores the future of data management, including emerging trends such as artificial intelligence, big data, and cloud computing. It discusses how these technologies will shape the way organizations collect, manage, and analyze data.

7. The seventh part of the document provides a summary of the key points discussed and offers recommendations for organizations looking to optimize their data management practices. It emphasizes the need for a proactive and continuous approach to data management.

8. The eighth part of the document includes a list of references and resources for further reading. It provides links to relevant articles, books, and industry reports that offer additional insights into the topics discussed in the document.

9. The ninth part of the document contains a glossary of key terms and definitions used throughout the document. This helps to ensure that all readers have a clear understanding of the terminology used in the text.

10. The tenth part of the document is a conclusion that summarizes the overall findings and reiterates the importance of effective data management for organizational success. It encourages organizations to embrace a data-driven culture and invest in the necessary resources and skills to succeed in the digital age.

11. The eleventh part of the document includes a list of appendices that provide additional information and data related to the main text. These appendices are organized in a way that allows readers to easily find the information they need.

12. The twelfth part of the document is a final section that provides contact information for the authors and any other relevant details. It also includes a disclaimer and a statement of copyright.

13. The thirteenth part of the document is a list of acknowledgments that thanks the individuals and organizations that provided support and assistance during the research and writing process. It is a way to express gratitude and recognize the contributions of others.

14. The final part of the document is a list of references that provides a comprehensive list of all the sources cited in the document. This allows readers to verify the information and explore the topics in more depth.

LOCAL PREFERENCE:

The City of Troy reserves the right to award a contract to a local business, one which pays City of Troy taxes (real and/or personal), if the bid of a local vendor is within 5% of the lowest responsive and responsible non-local bidder, then the local vendor is given one chance to match the low bid.

PURCHASE ORDER:

After approval of the successful bidder(s) by the Troy City Council, the purchase order issued from the City of Troy will create a bilateral contract between the parties and commit the successful bidder(s) to perform the contract in accordance with specifications. The Purchase orders will be released upon the City's acceptance of the specified insurance. A contract document/ agreement will not be issued.

CONTRACT FORMS:

Bidders should complete the Legal Status of Bidder, Non-Collusion Affidavit, Certification regarding Debarment and the Certification regarding "Iran Linked Business" forms and return with your bid proposal.

AUTHORIZED DEALER:

- Our company is an authorized distributor of the equipment specified
- Our company is not an authorized distributor of the equipment specified

SERVICE FACILITY:

Location: 45255 5 mile rd Plymouth MI

Number of miles from City of Troy: 35

Response Time for Service Calls: Within 48 hours to be onsite after initial request for service by a factory trained technician. (Number)

CONTACT INFORMATION:

Name(s): DAN COYNE 24 Hr. Phone No. 800-525-2739
DON KING 248-789-0469
 Hours of operation: 9-5 M-F

WARRANTY:

Please indicate the warranty items included in the bid price for the equipment bid. Each item must be completed with a Yes or No response.

WARRANTY DESCRIPTION	WARRANTY DURATION (Minimum)	INCLUDED	
		YES	NO
All "wear items" <u>NOT PAID</u>	3 Years	<input checked="" type="checkbox"/>	<input type="checkbox"/>
All parts and labor coverage	3 Years	<input checked="" type="checkbox"/>	<input type="checkbox"/>
Free second day parts shipping	3 Years	<input checked="" type="checkbox"/>	<input type="checkbox"/>
Free service call and technician travel at no additional cost to the City	3 Years	<input checked="" type="checkbox"/>	<input type="checkbox"/>

If your company can supply the warranty as described at an additional cost, please indicate this on supporting documentation marked NO additional cost for identification.

SUBCONTRACTORS:

Service and warranty work cannot be subcontracted. The successful bidders(s) must be able to service and repair the equipment bid with in-house personnel.

Our Company complies with this requirement: (Circle one) YES or NO

COMPANY NAME: All Pro Exercise

...the ... of ...

...the ... of ...

...the ... of ...

...the ... of ...

...the ... of ...

...the ... of ...

...the ... of ...

...the ... of ...

...the ... of ...

...the ... of ...

...the ... of ...

REFERENCES:

Please submit a list of *THREE CUSTOMERS* that currently use the make and model of the equipment bid. Include the name of the company, the address, phone number, contact person and email. The references are as follows:

COMPANY	ADDRESS	CONTACT PERSON	EMAIL	PHONE	YEAR PURCHASED
WARREN P&R	5160 Arden	Sheldon Miller	Smiller@cityofwarren.org	586-256-8400	2016
City of Grosse Pointe Park GP Park	GP Park	MAA, Beth HATHAWAY	HATHAWAY	313-622-1313	2016
MACOMB TWP P&R		GINA MUSZYNSKI	MUSZYNSKI@MACOMB-MI.GOV		2016

INSURANCE:

Insurance requirements shall be in accordance with the attached **SAMPLE INSURANCE CERTIFICATE** and **ENDORSEMENT**. The required Insurance Certificate and Endorsement must be submitted to the city within 5 days of the verbal/ electronic request after the bid award. The Insurance Certificate and Endorsement may be faxed to the Purchasing Office at (248) 619-7608, and is the only bid document accepted in this format.

The contractor, or any of their subcontractors, shall not commence work under this contract until they have obtained the insurance required, and shall keep such insurance in force during the entire life of this contract. All coverage shall be with insurance companies licensed and admitted to business in the State of Michigan and acceptable to the City of Troy. The requirements below should not be interpreted to limit the liability of the Contractor. All deductibles and self-insured retentions (SIR's) are the responsibility of the Contractor.

- We can meet the specified insurance requirements.
- We cannot meet the specified insurance requirements.
- We do not carry the specified limits but can obtain the additional insurance coverage of \$ _____, at the cost of \$ _____.
NOTE: Please note the amendments on a sample insurance certificate and attach it to your bid proposal.
- Our proposal is reduced by \$ _____ if we lower the requirement to \$ _____.
NOTE: Please note the amendments on a sample insurance certificate and attach it to your bid proposal.

IMPORTANT: A Certificate of Insurance on an ACORD Form showing present coverage as well as the required endorsements **SHALL** be attached to the proposal document at the time of submission of the proposal to the Office of the City Clerk.

NOTE: Failure on the part of any bidder to contact his/her insurance carrier to verify that the insurance carried by the bidder meets City of Troy specifications may result in this proposal being completed incorrectly.

OTHER: Sole proprietors must execute a certificate of exemption from Worker's Compensation requirements or provide proof of Worker's Compensation Insurance. All coverage shall be with insurance carriers licensed and admitted to do business in Michigan in accordance with all applicable statutes of the State of Michigan and acceptable to the City of Troy.

INSURANCE VERIFICATION:

A bidder shall complete the above portion, which details additional costs that may be incurred for specified coverage without purchasing the additional coverage prior to bid submission.

COMPANY NAME: All Pro Exercise

(

(

[Faint, illegible text covering the majority of the page, likely bleed-through from the reverse side.]

WORKERS' COMPENSATION INSURANCE, including Employers' Liability Coverage, in accordance with all applicable statutes of the State of Michigan.

COMMERCIAL GENERAL LIABILITY INSURANCE on an "Occurrence Basis" with limits of liability not less than \$1,000,000.00 per occurrence and aggregate. Coverage shall include the following extensions: (A) Contractual liability; (B) Products and Completed Operations; (C) Independent Contractors Coverage; (D) Broad Form General Liability Extensions or equivalent, if not already included; (E) Deletion of all Explosion, Collapse, and Underground (XCU) Exclusions, if applicable.

AUTOMOBILE LIABILITY, including Michigan No-Fault Coverages, with limits of liability not less than \$1,000,000.00 per occurrence combined single limit for Bodily Injury, and Property Damage. Coverage shall include all owned vehicles, all non-owned vehicles, and all hired vehicles.

ADDITIONAL INSURED:

Commercial General Liability and Automobile Liability, as described in the attached SAMPLE shall include an Additional Insured Endorsement stating the following shall be ***Additional Insureds***: The City of Troy including all elected and appointed officials, all employees and volunteers, all boards, commissions, and/or authorities and council members, including employees and volunteers thereof. It is understood and agreed by naming the City of Troy as additional insured, coverage afforded is considered to be primary and any other insurance the City of Troy may have in effect shall be considered secondary and/or excess.

CANCELLATION NOTICE:

All policies, as described above, shall include an endorsement stating that it is understood and agreed that Thirty (30) days, Ten (10) days for non-payment of premium, Advance Written Notice of Cancellation, Non-Renewal, Reduction, and/or Material Change shall be mailed to:

City of Troy
Purchasing Manager
500 West Big Beaver
Troy, MI 48084

PROOF OF INSURANCE COVERAGE:

The Contractor shall provide the City of Troy, at the time that the contracts are returned by him/her for execution, a Certificate of Insurance as well as the required endorsements. In lieu of required endorsements, if applicable, a copy of the policy sections where coverage is provided for additional insured and cancellation notice would be acceptable. Copies or certified copies of all policies mentioned above all shall be furnished, if so requested.

If any of the applicable coverages expire during the term of this contract, the Contractor shall deliver renewal certificates and endorsements to the City of Troy at least ten (10) days prior to the expiration date.

COMPANY NAME: _____

All PRO Exercise

1. The first part of the document is a list of names and addresses.

2. The second part of the document is a list of names and addresses.

3. The third part of the document is a list of names and addresses.

4. The fourth part of the document is a list of names and addresses.

5. The fifth part of the document is a list of names and addresses.

6. The sixth part of the document is a list of names and addresses.

7. The seventh part of the document is a list of names and addresses.

8. The eighth part of the document is a list of names and addresses.

9. The ninth part of the document is a list of names and addresses.

10. The tenth part of the document is a list of names and addresses.

11. The eleventh part of the document is a list of names and addresses.

12. The twelfth part of the document is a list of names and addresses.

13. The thirteenth part of the document is a list of names and addresses.

14. The fourteenth part of the document is a list of names and addresses.

15. The fifteenth part of the document is a list of names and addresses.

16. The sixteenth part of the document is a list of names and addresses.

17. The seventeenth part of the document is a list of names and addresses.

18. The eighteenth part of the document is a list of names and addresses.

19. The nineteenth part of the document is a list of names and addresses.

20. The twentieth part of the document is a list of names and addresses.

21. The twenty-first part of the document is a list of names and addresses.

22. The twenty-second part of the document is a list of names and addresses.

23. The twenty-third part of the document is a list of names and addresses.

24. The twenty-fourth part of the document is a list of names and addresses.

25. The twenty-fifth part of the document is a list of names and addresses.

26. The twenty-sixth part of the document is a list of names and addresses.

27. The twenty-seventh part of the document is a list of names and addresses.

28. The twenty-eighth part of the document is a list of names and addresses.

29. The twenty-ninth part of the document is a list of names and addresses.

30. The thirtieth part of the document is a list of names and addresses.

31. The thirty-first part of the document is a list of names and addresses.

32. The thirty-second part of the document is a list of names and addresses.

33. The thirty-third part of the document is a list of names and addresses.

34. The thirty-fourth part of the document is a list of names and addresses.

35. The thirty-fifth part of the document is a list of names and addresses.

36. The thirty-sixth part of the document is a list of names and addresses.

37. The thirty-seventh part of the document is a list of names and addresses.

38. The thirty-eighth part of the document is a list of names and addresses.

39. The thirty-ninth part of the document is a list of names and addresses.

40. The fortieth part of the document is a list of names and addresses.

SIGNATURE PAGE

PRICES:

Prices shall remain firm for 60 days or bid award, whichever comes first, except the successful bidder(s) whose prices shall remain firm through equipment delivery, trade-in pick-up, and final acceptance as operational in accordance with specifications.

SIGNATURE OF AUTHORIZED COMPANY REPRESENTATIVE: Donald R King

NOTE:

The undersigned has checked carefully the bid figures and understands that he/she shall be responsible for any error or omission in this bid offer and is in receipt of all addenda as issued.

TAX ID#: 382856821

COMPANY NAME: All Pro Exercise

ADDRESS 45255 Smile Rd CITY Plymouth STATE MI ZIP 48170

PHONE NUMBER 734-927-6500 FAX NUMBER 734-927-6504

REPRESENTATIVE'S NAME Donald R King

SIGNATURE OF AUTHORIZED COMPANY REPRESENTATIVE Donald R King (Print)

PAYMENT TERMS: NET 30 WARRANTY: AS SPECIFIED

E-MAIL: dking@allproexercise.com DELIVERY DATE: AS SPECIFIED

EXCEPTIONS:

Any exceptions, substitutions, deviations, etc., from the City specifications and this proposal must be stated below. The reason(s) for the exceptions, substitutions, and/or deviations are an integral part of this bid proposal offer:

NO EXCEPTIONS

Check this box if your bid is not to be broken up by item and based on an all or none award.

ACKNOWLEDGEMENT:

I, Donald R King, certify that I have read the **Instructions to Bidders** (2 Pages) and that the bid proposal documents contained herein were obtained directly from the City's Purchasing Department or MITN website, www.mitn.info and is an official copy of the Authorized Version.

SIGNATURE OF AUTHORIZED COMPANY REPRESENTATIVE: Donald R King

IMPORTANT: All City of Troy purchases require a MATERIAL SAFETY DATA SHEET, where applicable, in compliance with the MIOSHA "Right to Know" Law. Please include a copy of any relevant MSDS at the time of bid submission.

U.S. FUNDS: All prices quoted are to be in U.S. Currency.
G:\Bid\FitnessEquipment ITB-COT 16-35.doc

Faint, illegible text covering the majority of the page, possibly bleed-through from the reverse side. The text is too light to transcribe accurately.

Alternate Bid Equipment

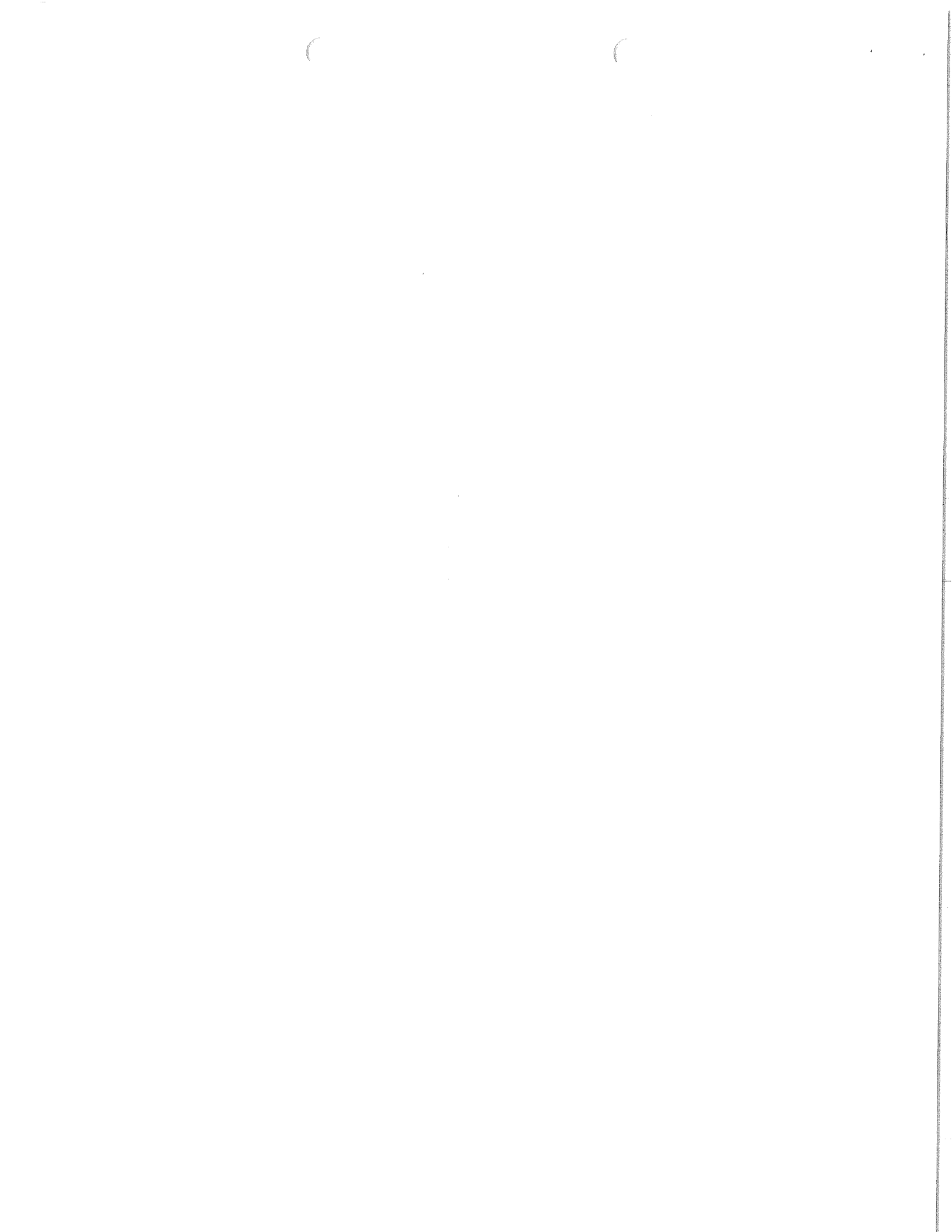

Caution: This Multi-Press is not a good design for the higher percentage of older members you have throughout most of the morning and Day-time hours. It requires the user to get into a “steep angle/laying back” position for the chest press and incline press. Getting up from these steep angles is not “user-friendly” for this age group (any age group).

VS. HOIST HD-3300: never requires the user to go beyond a 20 to 30 degree angles for any of the 3 exercises (Chest Press, Incline Press, Shoulder Press). Easier to use for all age groups

2. The exercise adjustment lever is below the user butt pad. This is a more difficult adjustment position. **VS. HOIST HD-3300 Multi Press:** with the **Pressing-Angle adjustment handle at “waist height” level** (a much easier adjustment for all users).

CO24ES Multi-Press

V The Vitality™ Series Multi-Press features 3 machines in one: bench press, incline press, and shoulder press. Users can adjust press arm and seat while on the machine. Comfortable, oversized grips with multiple positions and simple seat adjustment make it easy for users to get in position for proper exercise form. Users can easily engage the add-on weight with a simple push of a lever to increase the work load.

[GET QUOTE](#)

Share: [Facebook](#)

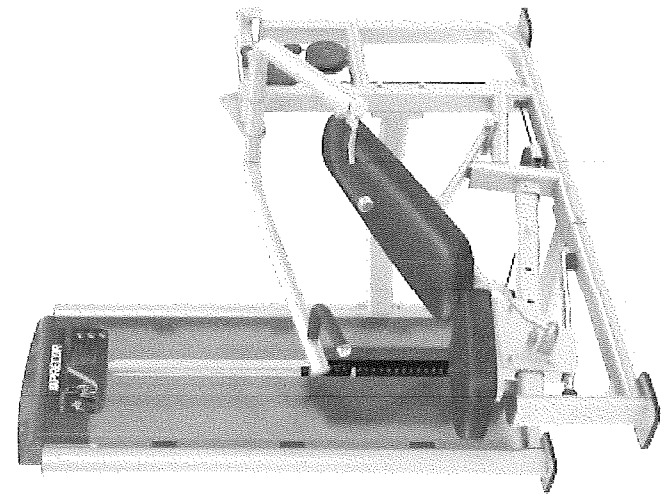

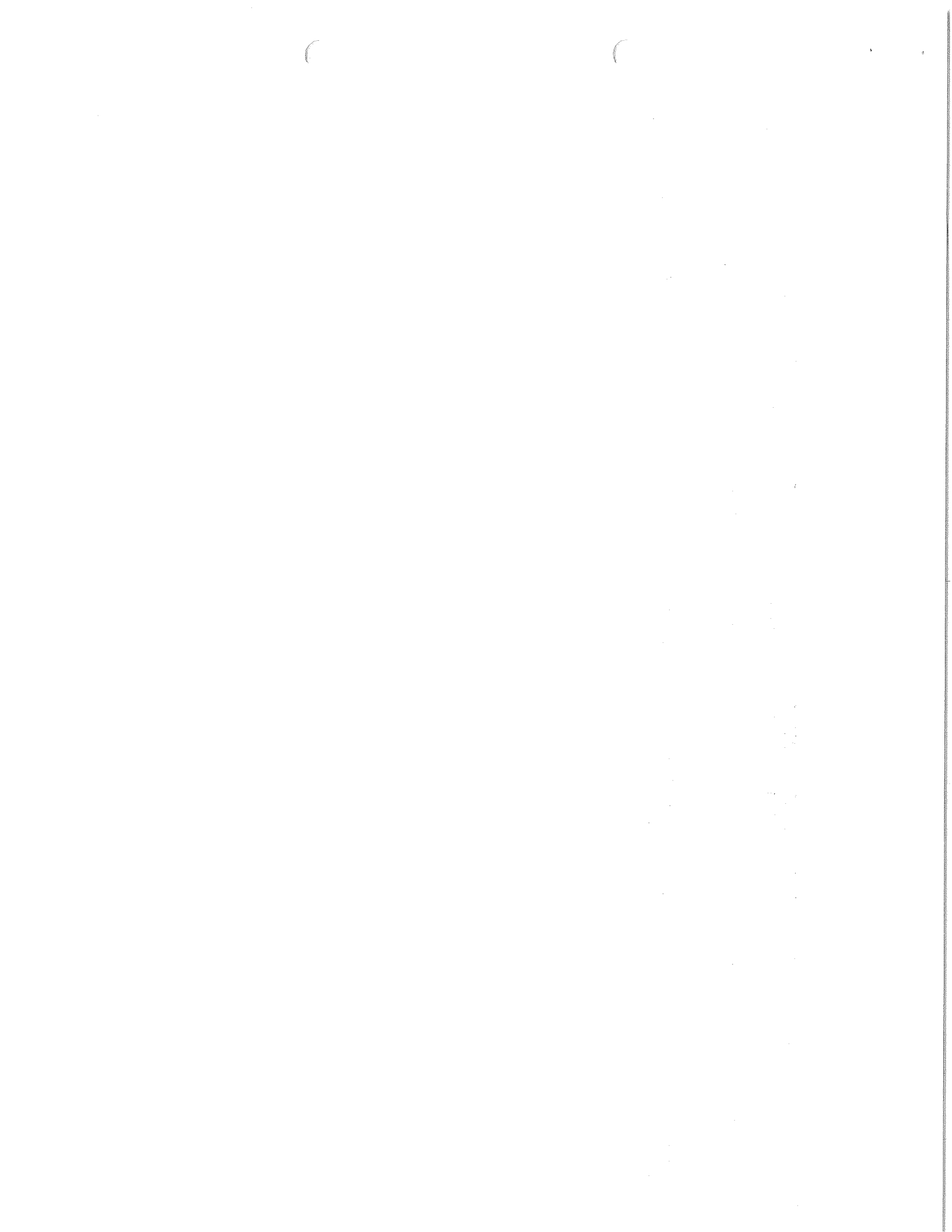

HOIST HD-3300 never requires the users to get up & down from laying on their back's to do the Chest Press or Incline Press. HOIST HD-3300 have ergonomic grip's with precise angles that reduce stress to wrist, elbow and shoulder joints.

[HD] DUALS SERIES

From the creators of the original Dual Series comes the expanded 3rd generation HOIST™ HD Dual Series offering a comprehensive solution for fitness facilities where space, budget or both are at a premium. Featuring the same aesthetic distinction and durable construction as the popular HOIST ROCKET™ line, the Dual Series offers B dual or multi-function stations. Utilizing flexibility in design, HOIST™ can provide a state-of-the-art strength circuit for almost any center. The HD Dual Series offers an exciting blend of quality components, intuitive adjustments, superior biomechanics and excellent value.

Comfort & Durability

- **Head Support & Oversized Handles**
Provides a more comfortable and secure workout
- **Oval Tube Frame**
Provides unsurpassed strength and durability

Convenience

- **Ratcheting Adjuster System**
Quick and easy seat adjustments to accommodate varying user sizes
- **Integrated Scuff Guards & Rubber Foot Protectors**
Protects the machine's frame finish and facility floor
- **Permanently anchor all HD products in place**
Maximizes user safety
- **Mobile instruction from your phone**
Scannable QR code with workout instructions on each machine

Sleek & Appealing

- **Large Radius Sweeps (bent)**
Adds beauty as well as frame rigidity

[HD] CHEST PRESS/SHOULDER RAISE

HD/HDC-3300

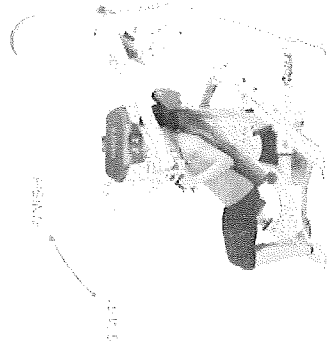
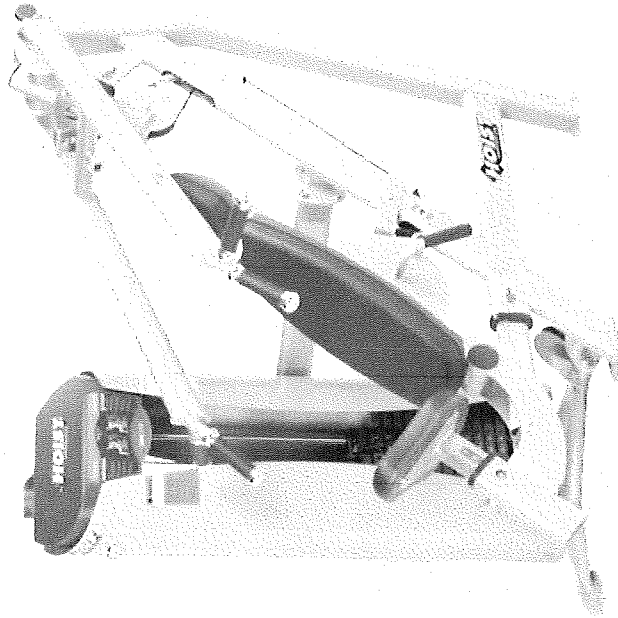
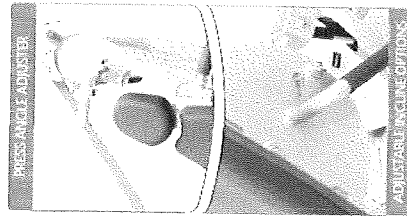

- Multiple seat and press arm positions
- One handed rotational angle adjustment for vertical chest, incline and shoulder press exercises
- Dual position hand grips



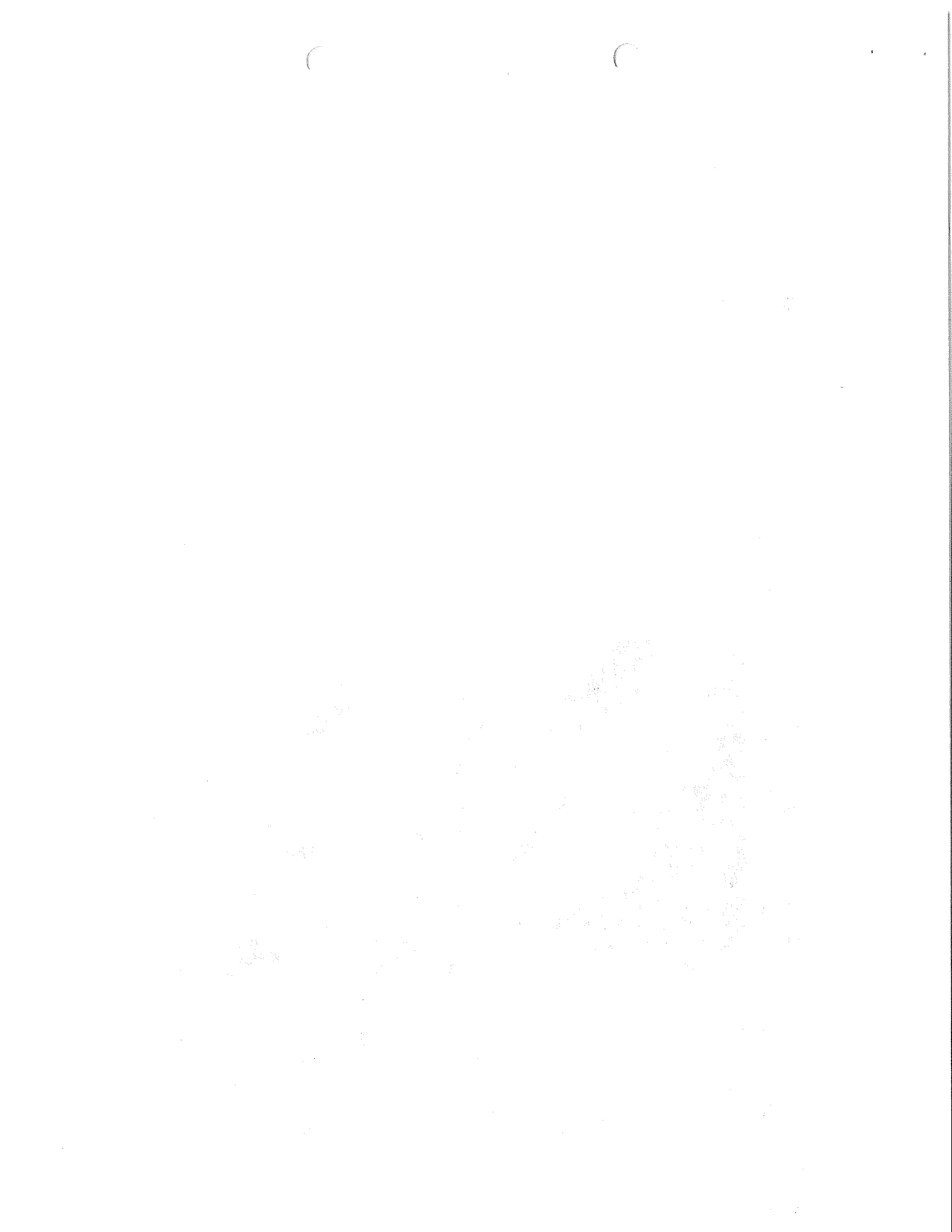

HOIST HD-3300 Multi-Press Your price 2195.00

CHEST PRESS, SHOULDER RAISE

HD-3300

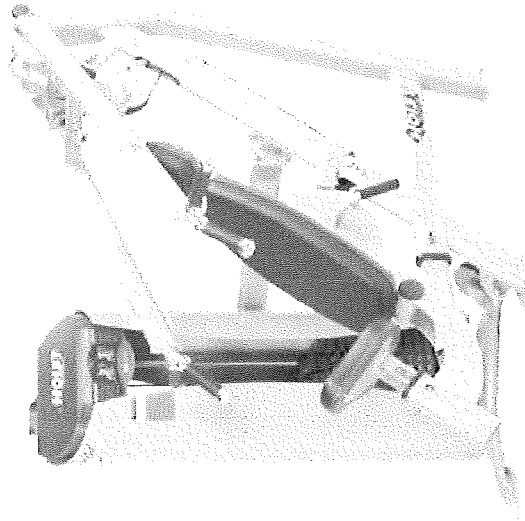

FEATURES

- Multiple seat and press arm positions
- One handed rotational angle adjustment for vertical chest, incline, and shoulder press exercises
- Dual position hand grips

- Product Dimensions L X W x H
61" X 62" X 59"
(155 cm x 158 cm x 150 cm)
- Product Weight: 522 lbs.
- Weight Stack:
215 lbs. (98 kg)

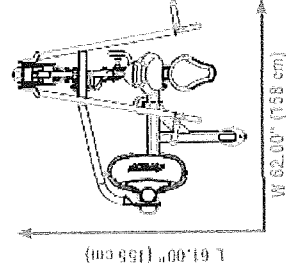

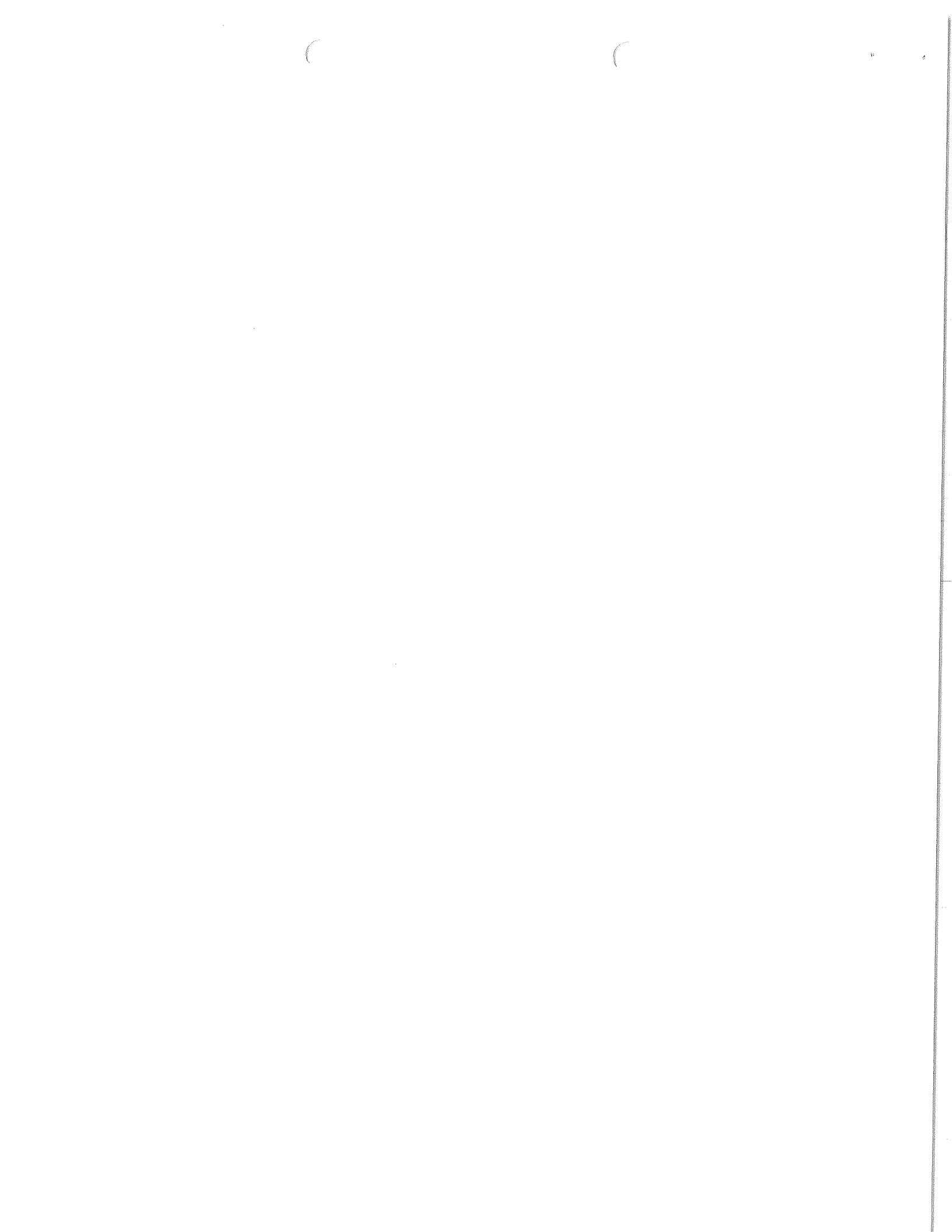

HOIST HD-3400 Leg Extension/Seated Leg Curl. Self adjusting Ankle Pad (one less adjustment control for your user's and one less Potential maintenance & repair mechanism for management). Your price 2195.00

LEG EXTENSION/LEG CURL

HD-3400

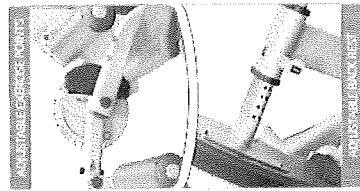
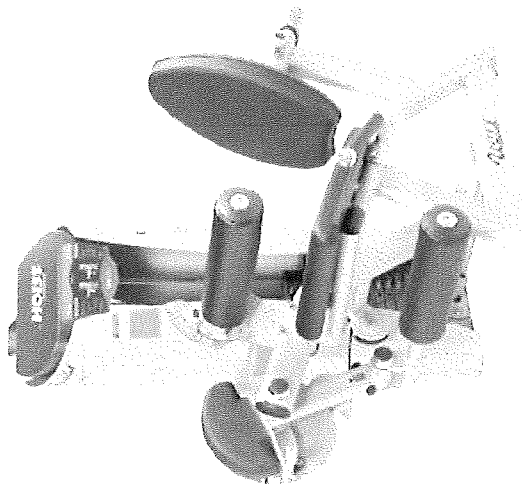

[HD] LEG CURL/LEG EXTENSION

HD/HCC-3400

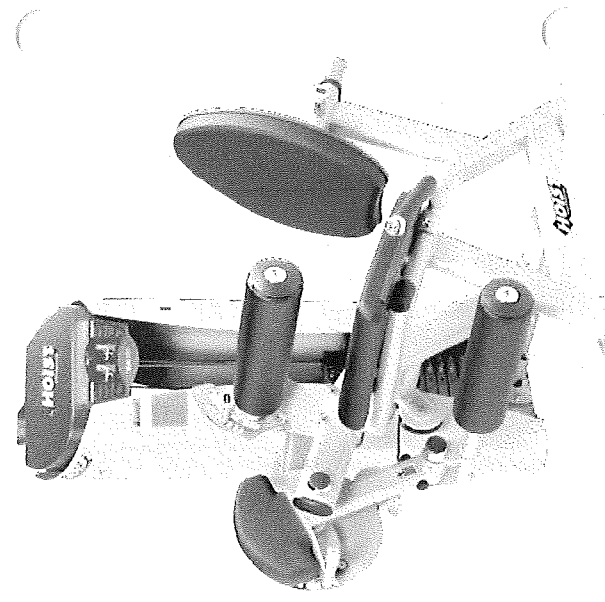

- Eight back pad adjustments for varying leg lengths
- Multiple range-of-motion adjustments for both exercises
- Self-aligning roller pad automatically adjusts to reduce potential stress of the ankle joints
- Product Dimensions L x W x H
50" [127 cm] x 51" x 55"
[127 cm] [165 cm] x 130 cm x 140 cm)
- Product Weight: 529 lbs.
- Weight Stack:
215 lbs. (98 kg)

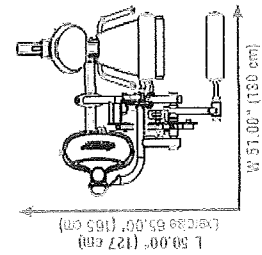
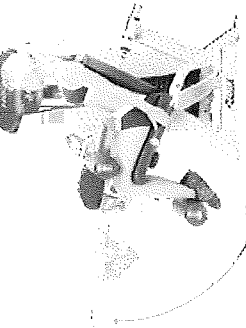

- Eight back pad adjustments for varying leg lengths
- Multiple range-of-motion adjustments for both exercises
- Self-aligning roller pad automatically adjusts to reduce potential stress of the ankle joints

EXERCISE: LEG EXTENSION

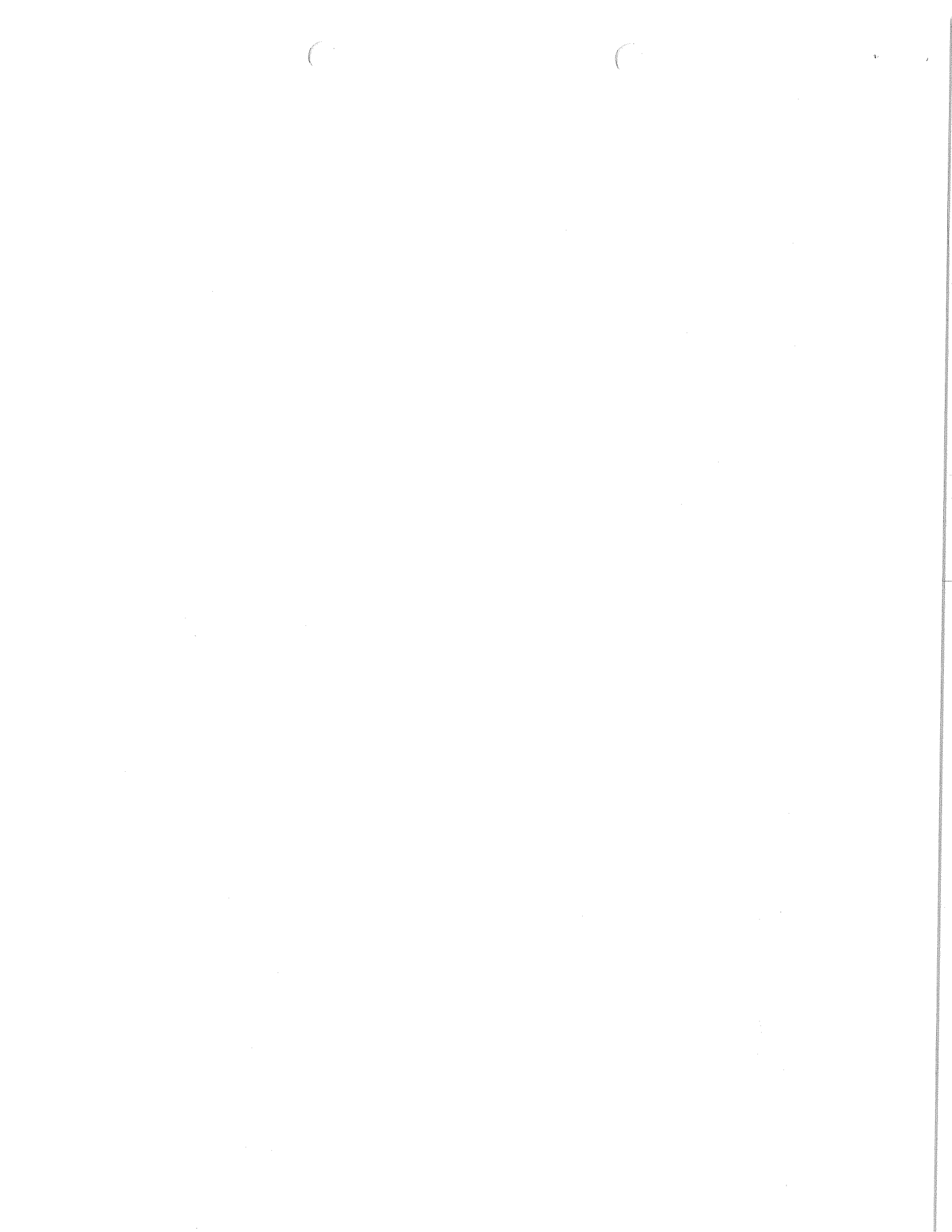

new

For 2016

GREEN Series™

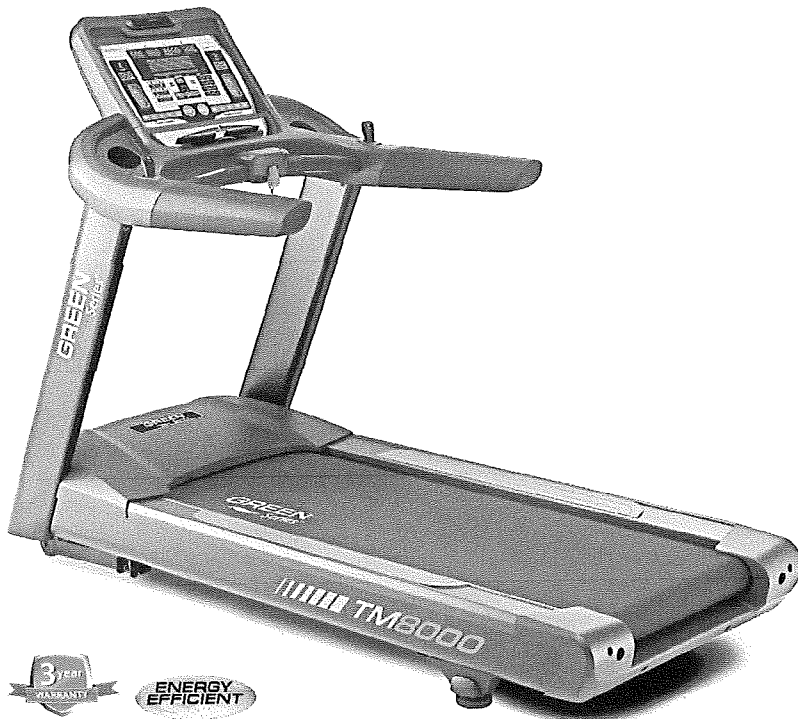

8000 TREADMILL CIR-TM8000-G

- 6.0 HP AC NextGEN III Eco-Drive System™
- 19" LED Console with Bluetooth® connectivity
- 60" L x 22" W Lubricant-infused 25,000 mile maintenance-free running belt
- 500 lbs. Max user weight capacity
- Quick speed and elevation paddle shifters and toggle shifters on console
- CSAFE power port and USB charging station
- Contact and telemetric heart-rate sensors, personal cooling fan and 20 + programs
- Zinc-dipped anti-corrosion coating for superior rust protection
- Optional:** 19" Embedded touchscreen with TV, WiFi and Virtual Connect™ Scenic Videos
- Full commercial use**



19" LED Console with toggle shifters & reading rack/tablet holder

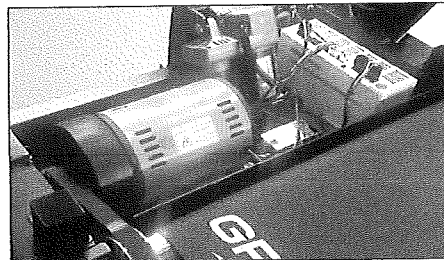

6.0 HP, AC NextGEN III Eco-Drive System™



Quick speed & elevation paddle shifters

Overall Weight	Running Surface	Width	Length	Height
456 lbs.	60"L x 22"W	37"	85"	60"

FEATURES AND SPECIFICATIONS

Frame: Zinc-dipped and powder-coated steel frame
Motor: 6.0 HP, AC NextGEN III Eco-Drive System™
Electrical: 120V, 20 amp dedicated outlet NEMA 5-20
Certification: CE and motor UL
Rollers: 3.5"
Step Up Height: 10"
Color: Matte-black
Belt and Deck: 60" L x 22" W running surface, 25,000 mile maintenance-free Habisit® premium lubricant-infused running belt with pre-waxed 1" thick reversible Stikdek™
Incline Range: 0 to 20% incline
Speed Range: 0.2 - 17.2 MPH
User Weight: 500 lbs.

Transport Wheels: Easy-to-move with front-mounted dual wheels without elevating

Heart Rate Monitoring: Contact and telemetric heart-rate sensors

Display Type: 19" LED + 8x32 Dot-Matrix Console

Display Feedback: Time, distance, heart-rate, calories, speed, incline, exercise summary report

Programs: Over 20, including 5 courses, 3 goals, 8 tests (including Gerkin and military), 4 heart rate & custom courses

Standard Features: Hand pulse, fan, HR receiver chest belt compatible, 5 key quick speed & incline, reading rack/tablet holder, Bluetooth® connectivity, CSAFE power port & USB charging station

Warranty: 10 years frame, 7 years motors, 3 years parts, 2 years wearable items, 1 year labor*

* Upgraded to 6 years parts in light commercial applications





**BID SPECIFICATIONS
PHYSICAL FITNESS EQUIPMENT**

GENERAL:

The Troy Community Center, located at 3179 Livernois, Troy, Michigan, 48083, is seeking to purchase and have installed eighteen (18) pieces of new Commercial Grade Physical Fitness Equipment for the Fitness Room. The fitness equipment bid must meet all requirements as specified. Brian Goul, Assistant Recreation Director is the contact for this project. (No substitutions will be allowed). All equipment is to be F.O.B. delivered freight paid with inside delivery to this location.

NEW EQUIPMENT TO PURCHASE: (18)

- 2 each – PreCor Vitality Multi-Press CO24ES
- 2 each – PreCor Vitality Leg Extension/ Leg Curl CO27ES
- 2 each – FreeMotion i11.9 Incline Treadmill
- 6 each – Matrix #T5x heavy duty treadmill
- 3 each – Matrix A3x heavy commercial Ascent Trainer
- 2 each – Matrix E3x heavy commercial Elliptical
- 1 each – Octane XR6000 XRide Seated Total Body Elliptical

EQUIPMENT TRADE-INS: (18)

- One (1) Lifefitness Hammer Strength Shoulder Press - 2002
- One (1) Lifefitness Hammer Strength Incline Press - 2002
- One (1) Lifefitness Hammer Strength Leg Curl – 2002
- One (1) Lifefitness Hammer Strength Leg Extension - 2002
- Eight (8) Matrix #T5x – 2013 Treadmills
- Three (3) Matrix A3x Ascent Trainers - 2013
- Two (2) Matrix E3x Elliptical - 2013
- One (1) Octane XR6000 XRide- 2012

Any prospective bidders may schedule an on-site appointment in order to inspect the existing equipment to be traded-in before bids are submitted. Please contact Brian Goul, Assistant Recreation Director at (248) 524-3484, between the hours of 8:00 am and 4:30 pm, Monday through Friday to make an appointment.

WARRANTY:

Minimum three (3) years warranty on the following:

- All parts and labor coverage
- All “wear items” (including running decks, belts, shrouds, grips, controls, etc)
- Free second day parts shipping.
- Free service calls (24 Hours) and technician travel at no additional cost to the City

[The page contains extremely faint and illegible text, likely bleed-through from the reverse side of the document. The text is too light to transcribe accurately.]

DETAILED REQUIREMENTS:

1. The successful bidder(s) must provide a manufacturer approved 3-year warranty that stipulates if something breaks during "normal" use, the vendor will cover all labor and materials to ensure complete repair of the unit at no cost to the City of Troy.
2. The repair (vendor) facility must be within 100 miles of the City of Troy. The successful bidder(s) must be able to respond to a service request by phone within 24 hours and be able to be on site for service calls within 48 hours after initial service request. Any non-stock defective parts will be replaced at no cost to the City within three (3) calendar days from date of service call.
3. The successful bidder(s) must be an authorized dealer of the equipment that is being supplied.
4. All equipment must be new.
5. The successful bidder(s) must install the equipment.
6. The successful bidder(s) must train the Recreation Staff in the proper use and everyday maintenance of the equipment.
7. Service and warranty work cannot be subcontracted. The successful bidder(s) must be able to service and repair the equipment bid with in-house personnel.



Faint, illegible text, possibly bleed-through from the reverse side of the page. The text is arranged in several paragraphs and is too light to transcribe accurately.



**CERTIFICATION REGARDING
DEBARMENT, SUSPENSION, AND OTHER RESPONSIBILITY MATTERS**

The prospective participant certifies, to the best of its knowledge and belief, that it and its principals:

1. Are not presently debarred, suspended, proposed for debarment, declared ineligible, or voluntarily excluded from participation in transactions under any non-procurement programs by any federal, state or local agency.
2. Have not, within the three year period preceding, had one or more public transactions (federal, state, or local) terminated for cause or default; and
3. Are not presently indicted or otherwise criminally or civilly charged by a government entity (federal, state, or local) and have not, within the three year period preceding the proposal, been convicted of or had a civil judgment rendered against it:
 - a. For the commission of fraud or a criminal offense in connection with obtaining, attempting to obtain, or performing a public transaction (federal, state, or local), or a procurement contract under such a public transaction;
 - b. For the violation of federal, or state antitrust statutes, including those proscribing price fixing between competitors, the allocation of customers between competitors, or bid rigging; or
 - c. For the commission of embezzlement, theft, forgery, bribery, falsification or destruction of records, making false statements, or receiving stolen property.

I understand that a false statement on this certification may be grounds for the rejection of this proposal or the termination of the award. In addition, the general grant of this authority exists within the City's Charter, Chapter 12, Section 12.2- Contracts.

I am able to certify to the above statements.

All PRO Exercise

Name of Agency/Company/Firm (Please Print)

Donald R King

Name and title of authorized representative (Please Print)

Donald R King

Signature of authorized representative

Date

I am unable to certify to the above statements. Attached is my explanation.



[The text in this section is extremely faint and illegible. It appears to be a series of paragraphs or a list of items, but the specific content cannot be discerned.]





**VENDOR CERTIFICATION
THAT IT IS NOT AN
"IRAN LINKED BUSINESS"**

Pursuant to Michigan law, (the Iran Economic Sanctions Act, 2012 PA 517, MCL 129.311 et seq.), before accepting any bid or proposal, or entering into any contract for goods or services with any prospective Vendor, the Vendor must first certify that it is not an "IRAN LINKED BUSINESS", as defined by law.

Vendor	
Legal Name	ALL PRO EXERCISE
Street Address	45255 5 mile Rd
City	Plymouth TWP
State, Zip	MI 48170
Corporate I.D. Number/State	N/A
Taxpayer I.D. #	382856821

The undersigned, with: 1.)full knowledge of all of Vendors business activities, 2.)full knowledge of the requirements and possible penalties under the law MCL 129.311 et seq. and 3.) the full and complete authority to make this certification on behalf of the Vendor, by his/her signature below, certifies that: the Vendor is NOT an "IRAN LINKED BUSINESS" as require by MCL 129.311 et seq., and as such that Vendor is legally eligible to submit a bid and be considered for a possible contract to supply goods and/or services to the City of Troy.

Signature of Vendor's Authorized Agent:

Donald R King

Printed Name of Vendor's Authorized Agent:

Donald R King

Witness Signature:

Tabitha Spyrka

Printed Name of Witness:

TABITHA SPYRKA

1. The first part of the document discusses the importance of maintaining accurate records of all transactions and activities. It emphasizes that this is crucial for ensuring transparency and accountability in the organization's operations.

2. The second part of the document outlines the various methods and tools used to collect and analyze data. It highlights the need for consistent and reliable data collection processes to support effective decision-making.

3. The third part of the document focuses on the role of technology in data management and analysis. It discusses how modern software solutions can streamline data collection, storage, and reporting, thereby improving efficiency and accuracy.

4. The fourth part of the document addresses the challenges associated with data management, such as data quality, security, and privacy. It provides strategies to mitigate these risks and ensure that data is used responsibly and ethically.

5. The fifth part of the document concludes by summarizing the key findings and recommendations. It stresses the importance of ongoing monitoring and evaluation to ensure that data management practices remain effective and aligned with the organization's goals.

6. The sixth part of the document provides a detailed overview of the data collection process, including the selection of data sources, the design of data collection instruments, and the implementation of data collection procedures.

7. The seventh part of the document discusses the various methods used for data analysis, such as descriptive statistics, inferential statistics, and qualitative analysis. It explains how these methods are used to interpret the data and draw meaningful conclusions.

8. The eighth part of the document provides a final summary and highlights the key takeaways from the document. It encourages the organization to continue to refine its data management practices and to stay up-to-date with the latest developments in the field.



Legal Status of Bidder:

The Bidder shall fill out the appropriate form and strike out the other two:

A **corporation** duly organized and doing business under the laws of the State of Michigan
_____ for whom DAVE Smith, bearing the office title of owner
_____, whose signature is affixed to this proposal, is duly authorized to execute
contracts.

A **partnership**, all members of which, with addresses, is:

_____	_____
_____	_____
_____	_____
_____	_____
_____	_____
_____	_____
_____	_____

AN **INDIVIDUAL**, WHOSE SIGNATURE IS AFFIXED TO THE PROPOSAL:

Dave Smith _____

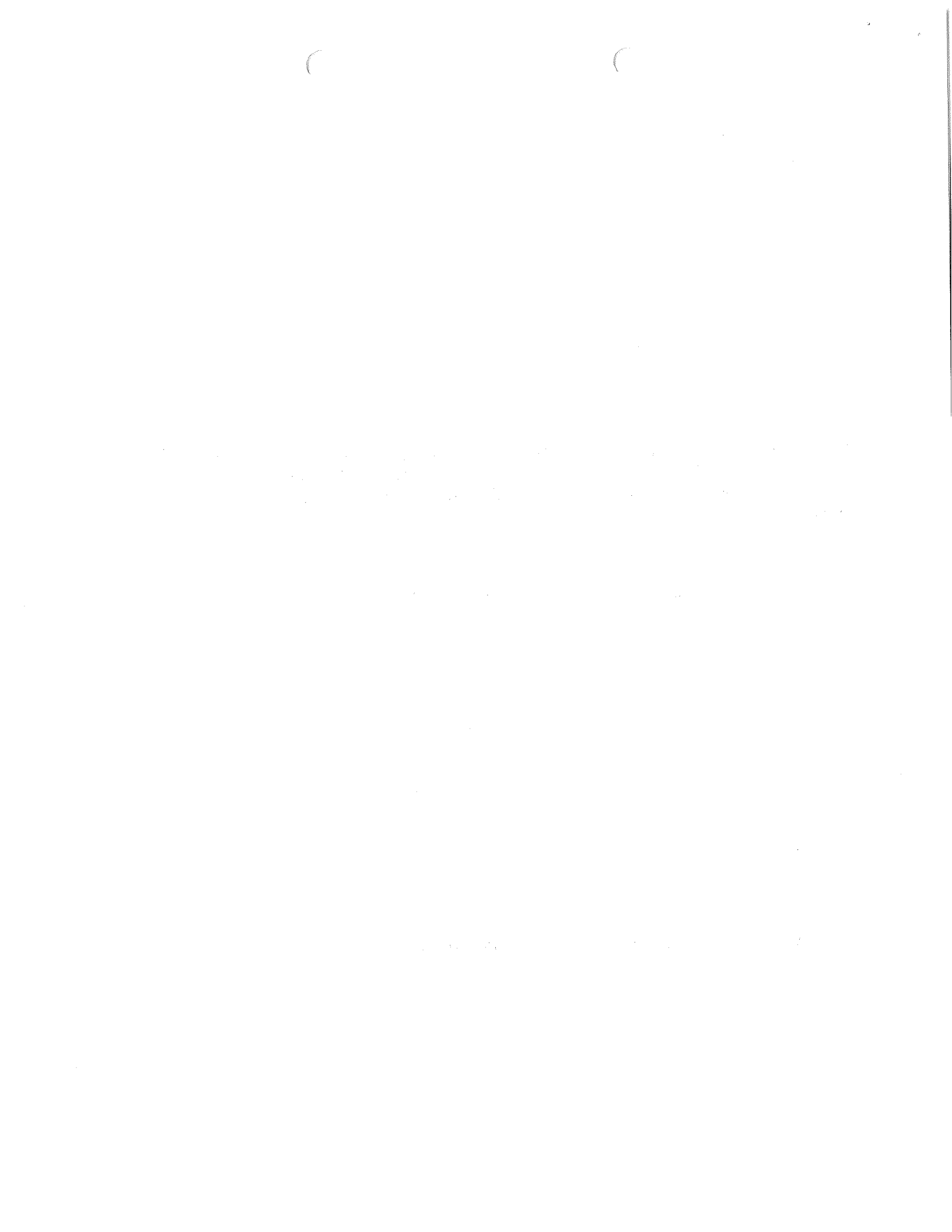



CITY OF TROY
OAKLAND COUNTY, MICHIGAN
NON-COLLUSION AFFIDAVIT

TO WHOM IT MAY CONCERN:

Donald R King, being duly sworn deposed, says that he/she
(Print Full Name)

is Sales Representative. The party making the foregoing proposal or bid,
(State Official Capacity in Firm)

that such bid is genuine and not collusion or sham; that said bidder has not colluded, conspired, connived, or agree, directly or indirectly, with any bidder or person, to put in a sham bid or to refrain from bidding and has not in any manner directly or indirectly sought by agreement or collusion, or communication or conference, with any person to fix the bid price or affiant or any other bidder, or to fix any overhead, profit, or cost element of said bid price, or that of any other bidder, or to secure the advantage against the City of Troy or any person interested in the proposed contract; and that all statements contained in said proposal or bid are true.

Donald R King
SIGNATURE OF PERSON SUBMITTING BID

Tabitha Szpyra
NOTARY'S SIGNATURE

Subscribed and sworn to before me this 19th day of
October, 2016 in and for Macomb County.

My commission expires: 03.18.2021

TABITHA SZPYRA
NOTARY PUBLIC - STATE OF MICHIGAN
COUNTY OF MACOMB
My Commission Expires Mar. 18, 2021
Acting in the County of Macomb

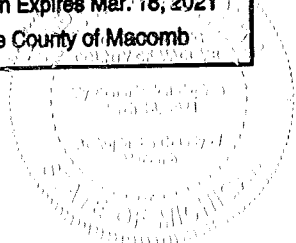

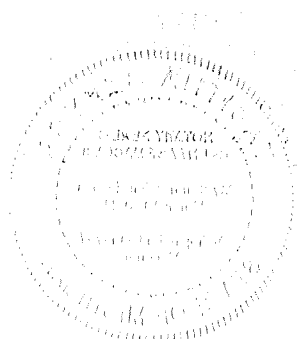





**CITY OF TROY
BID PROPOSAL**

ITB-COT 16-35
Page 1 of 6

The undersigned proposes to purchase and install **NEW PHYSICAL FITNESS EQUIPMENT FOR THE TROY COMMUNITY CENTER LESS TRADE-INS**, in accordance with the specifications, which are to be considered an integral part of this proposal, at the following prices:

COMPANY NAME: Direct Fitness Solutions, LLC

PROPOSAL: TO PURCHASE AND INSTALL EIGHTEEN (18) PIECES OF PHYSICAL FITNESS EQUIPMENT FOR THE TROY COMMUNITY CENTER FITNESS ROOM LESS TRADE-INS IN ACCORDANCE WITH THE ATTACHED SPECIFICATIONS AS FOLLOWS:

The undersigned, as bidder, declares that he/she has examined the specifications, including related documents. Being familiar with the conditions in the City of Troy and the type of work required, the bidder hereby proposes to furnish all labor, materials, equipment and supplies, to provide the services specified in the bid proposal documents, at the prices stated below. These prices are to cover all expenses incurred in performing the work required:

EQUIPMENT TO PURCHASE (1 for 1 trade-in exchange)				
	Quantity	Description (No Substitutions)	Unit Cost (Each)	Estimated Total Cost
1	Two (2)	PreCor Vitality Multi-Press CO24ES	\$ 2495 /ea	\$ 4990
2	Two (2)	PreCor Vitality Leg Extension/Leg Curl CO27ES	\$ 2495 /ea	\$ 4990
3	Two (2)	FreeMotion i11.9 Incline Treadmill	\$ 5495 /ea	\$ 10990
4	Six (6)	Matrix #T5x-2016, heavy ^{PreCor} commercial treadmill _{TRM731}	\$ 4895 /ea	\$ 29370
5	Three (3)	Matrix A3x heavy commercial Ascent Trainer ^{PreCor} _{AT7813}	\$ 4995 /ea	\$ 14985
6	Two (2) ^{PreCor} _{AT7813}	Matrix E3x heavy commercial Elliptical	\$ 4395 /ea	\$ 8790
7	One (1)	Octane XR6000 X Ride Seated Total Body Elliptical _{SQFTRX7001}	\$ 4550 /ea	\$ 4550
8	TRADE-INS			
	Quantity	Description	Estimated Trade-In Amount (Each)	Estimated Trade-In Amount Total
	One (1)	Lifefitness Hammer Strength Shoulder Press - 2002	(\$ 200)	(\$200)
	One (1)	Lifefitness Hammer Strength Incline Press-2002	(\$ 200)	(\$200)
	One (1)	Lifefitness Hammer Strength Leg Curl - 2002	(\$ 200)	(\$200)
	One (1)	Lifefitness Hammer Strength Leg Extension-2002	200	200
	Eight (8)	Matrix #T5x - 2013 Treadmills	(\$ 500)	(\$4000) 4000
	Three (3)	Matrix A3x Ascent Trainers - 2013	(\$ 500)	(\$1500)
	Two (2)	Matrix E3x Elliptical - 2013	(\$ 500)	(\$ 1000)
	One (1)	Octane XR6000 XRide - 2012	(\$ 700)	(\$ 700)
		DEDUCT:	(\$)	(\$8000)
			Estimated Net Total Cost	\$ 70,665

REFERENCES:

Please submit a list of *THREE CUSTOMERS* that currently use the make and model of the equipment bid. Include the name of the company, the address, phone number, contact person and email. The references are as follows:

COMPANY	ADDRESS	CONTACT PERSON	EMAIL	PHONE	YEAR PURCHASED
Macomb Recreation Ctr.	20699 Macomb	Gina Muszynski		586-992-2905	2016
Summit in the Park	6000 Summit Parkway	Jason Lombardo		734-374-5473	2016
Livonia Recreation Ctr.	6100 Stark Rd	Scott Spahr		734-466-0910	2015

INSURANCE:

Insurance requirements shall be in accordance with the attached **SAMPLE INSURANCE CERTIFICATE** and **ENDORSEMENT**. The required Insurance Certificate and Endorsement must be submitted to the city within 5 days of the verbal/ electronic request after the bid award. The Insurance Certificate and Endorsement may be faxed to the Purchasing Office at (248) 619-7608, and is the only bid document accepted in this format.

The contractor, or any of their subcontractors, shall not commence work under this contract until they have obtained the insurance required, and shall keep such insurance in force during the entire life of this contract. All coverage shall be with insurance companies licensed and admitted to business in the State of Michigan and acceptable to the City of Troy. The requirements below should not be interpreted to limit the liability of the Contractor. All deductibles and self-insured retentions (SIR's) are the responsibility of the Contractor.

- We can meet the specified insurance requirements.
- We cannot meet the specified insurance requirements.
- We do not carry the specified limits but can obtain the additional insurance coverage of \$ _____, at the cost of \$ _____.

NOTE: Please note the amendments on a sample insurance certificate and attach it to your bid proposal.

- Our proposal is reduced by \$ _____ if we lower the requirement to \$ _____.

NOTE: Please note the amendments on a sample insurance certificate and attach it to your bid proposal.

IMPORTANT: A Certificate of Insurance on an ACORD Form showing present coverage as well as the required endorsements SHALL be attached to the proposal document at the time of submission of the proposal to the Office of the City Clerk.

NOTE: Failure on the part of any bidder to contact his/her insurance carrier to verify that the insurance carried by the bidder meets City of Troy specifications may result in this proposal being completed incorrectly.

OTHER: Sole proprietors must execute a certificate of exemption from Worker's Compensation requirements or provide proof of Worker's Compensation Insurance. All coverage shall be with insurance carriers licensed and admitted to do business in Michigan in accordance with all applicable statutes of the State of Michigan and acceptable to the City of Troy.

INSURANCE VERIFICATION:

A bidder shall complete the above portion, which details additional costs that may be incurred for specified coverage without purchasing the additional coverage prior to bid submission.

COMPANY NAME: Direct Fitness Solutions, LLC

(0

(0

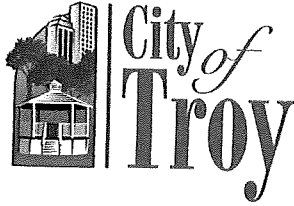

**VENDOR CERTIFICATION
THAT IT IS NOT AN
"IRAN LINKED BUSINESS"**

Pursuant to Michigan law, (the Iran Economic Sanctions Act, 2012 PA 517, MCL 129.311 et seq.), before accepting any bid or proposal, or entering into any contract for goods or services with any prospective Vendor, the Vendor must first certify that it is not an "IRAN LINKED BUSINESS", as defined by law.

Vendor	
Legal Name	Direct Fitness Solutions, LLC
Street Address	600 Tower Road
City	Mundelein
State, Zip	IL 60060
Corporate I.D. Number/State	
Taxpayer I.D. #	36-4202633

The undersigned, with: 1.) full knowledge of all of Vendor's business activities, 2.) full knowledge of the requirements and possible penalties under the law MCL 129.311 et seq. and 3.) the full and complete authority to make this certification on behalf of the Vendor, by his/her signature below, certifies that: the Vendor is NOT an "IRAN LINKED BUSINESS" as required by MCL 129.311 et seq., and as such that Vendor is legally eligible to submit a bid and be considered for a possible contract to supply goods and/or services to the City of Troy.

Signature of Vendor's Authorized Agent:



Printed Name of Vendor's Authorized Agent:

Mark Kwiatkowski

Witness Signature:



Printed Name of Witness:

Vaughn C. Mober



CITY OF TROY
OAKLAND COUNTY, MICHIGAN
NON-COLLUSION AFFIDAVIT

TO WHOM IT MAY CONCERN:

Mark Kwiatkowski, being duly sworn deposed, says that he/she
(Print Full Name)

is Regional Sales Manager. The party making the foregoing proposal or bid,
(State Official Capacity in Firm)

that such bid is genuine and not collusion or sham; that said bidder has not colluded, conspired, connived, or agree, directly or indirectly, with any bidder or person, to put in a sham bid or to refrain from bidding and has not in any manner directly or indirectly sought by agreement or collusion, or communication or conference, with any person to fix the bid price or affiant or any other bidder, or to fix any overhead, profit, or cost element of said bid price, or that of any other bidder, or to secure the advantage against the City of Troy or any person interested in the proposed contract; and that all statements contained in said proposal or bid are true.

[Signature]
SIGNATURE OF PERSON SUBMITTING BID

[Signature]
NOTARY'S SIGNATURE

Subscribed and sworn to before me this 19th day of October, 2016 in and for Wayne County.

My commission expires:
Vaughn Molnar
Notary Public, State of Michigan
County of Wayne
Acting in Wayne County
My Commission Expires
January 12, 2018

My Commission Expires
on 01/01/2010
County of Wayne
Michigan State of Michigan
Michigan State of Michigan



**CERTIFICATION REGARDING
DEBARMENT, SUSPENSION, AND OTHER RESPONSIBILITY MATTERS**

The prospective participant certifies, to the best of its knowledge and belief, that it and its principals:

1. Are not presently debarred, suspended, proposed for debarment, declared ineligible, or voluntarily excluded from participation in transactions under any non-procurement programs by any federal, state or local agency.
2. Have not, within the three year period preceding, had one or more public transactions (federal, state, or local) terminated for cause or default; and
3. Are not presently indicted or otherwise criminally or civilly charged by a government entity (federal, state, or local) and have not, within the three year period preceding the proposal, been convicted of or had a civil judgment rendered against it:
 - a. For the commission of fraud or a criminal offense in connection with obtaining, attempting to obtain, or performing a public transaction (federal, state, or local), or a procurement contract under such a public transaction;
 - b. For the violation of federal, or state antitrust statutes, including those proscribing price fixing between competitors, the allocation of customers between competitors, or bid rigging; or
 - c. For the commission of embezzlement, theft, forgery, bribery, falsification or destruction of records, making false statements, or receiving stolen property.

I understand that a false statement on this certification may be grounds for the rejection of this proposal or the termination of the award. In addition, the general grant of this authority exists within the City's Charter, Chapter 12, Section 12.2- Contracts.

I am able to certify to the above statements.

Direct Fitness Solutions, LLC

Name of Agency/Company/Firm (Please Print)

Mark Kwiatkowski, Regional Sales Manager

Name and title of authorized representative (Please Print)

Mark Kwiatkowski

Signature of authorized representative

Date

I am unable to certify to the above statements. Attached is my explanation.

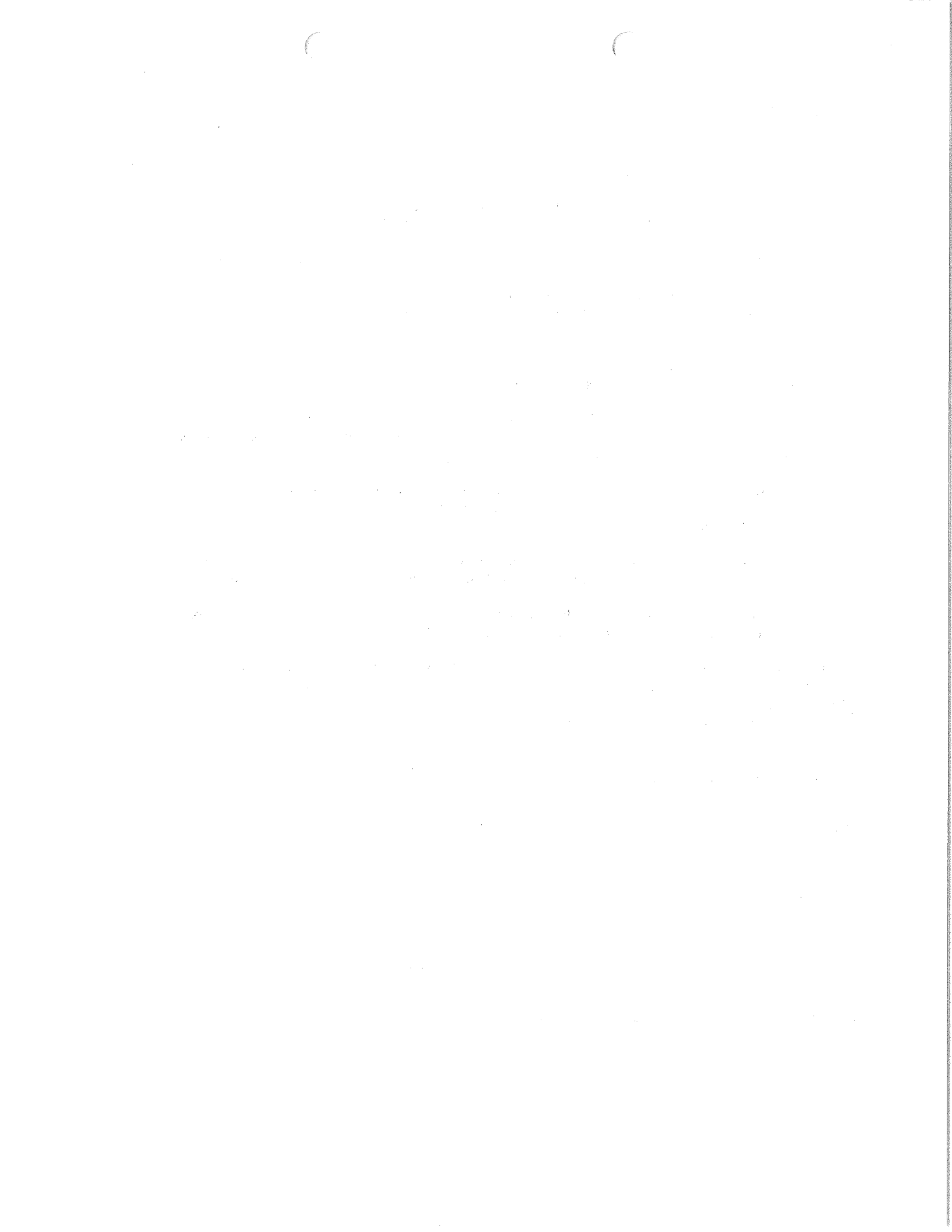

COMPLETE
FITNESS
SOLUTIONS



VITALITY SERIES™

MPRECOR®

Vitality Series™ - Upper Body, Lower Body and Core

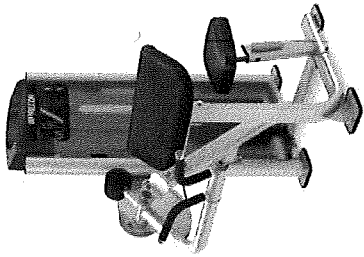

C003ES

Biceps Curl

- Dimensions (LxWxH): 119 x 102 x 145 cm (47 x 40 x 57 in)
- Weight: 180 kg (395 lbs)
- Weight stack: 78 kg (170 lbs)

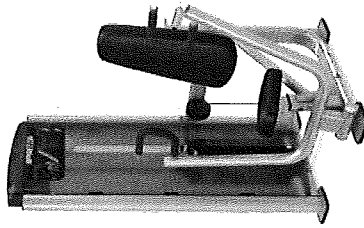

C001ES

Chest Press

- Dimensions (LxWxH): 99 x 130 x 175 cm (39 x 51 x 69 in)
- Weight: 205 kg (450 lbs)
- Weight stack: 110 kg (240 lbs)

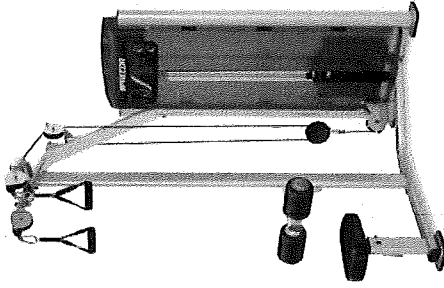

C002ES

Pulldown*

- Dimensions (LxWxH): 102 x 140 x 216 cm (40 x 55 x 85 in)
- Weight: 215 kg (475 lbs)
- Weight stack: 100 kg (220 lbs)

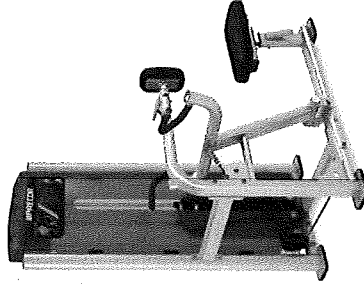

C019ES

Seated Row

- Dimensions (LxWxH): 127 x 119 x 175 cm (50 x 47 x 69 in)
- Weight: 210 kg (460 lbs)
- Weight stack: 110 kg (240 lbs)

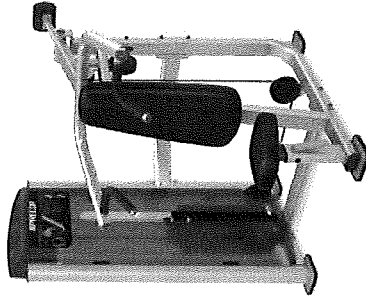

C012ES

Shoulder Press

- Dimensions (LxWxH): 150 x 142 x 145 cm (59 x 56 x 57 in)
- Weight: 195 kg (430 lbs)
- Weight stack: 91 kg (200 lbs)

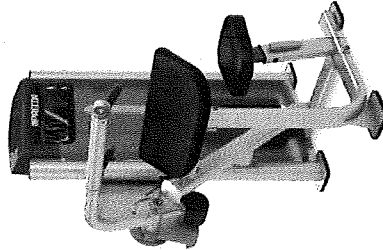

C023ES

Triceps Extension

- Dimensions (LxWxH): 117 x 102 x 145 cm (46 x 40 x 57 in)
- Weight: 180 kg (395 lbs)
- Weight stack: 78 kg (170 lbs)

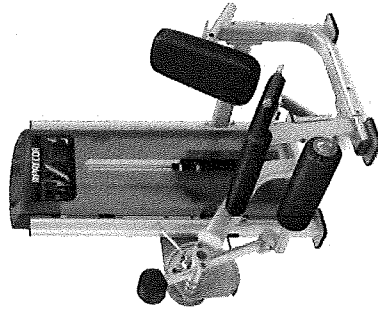

C005ES

Leg Extension

- Dimensions (LxWxH): 132 x 109 x 145 cm (52 x 43 x 57 in)
- Weight: 210 kg (460 lbs)
- Weight stack: 91 kg (200 lbs)

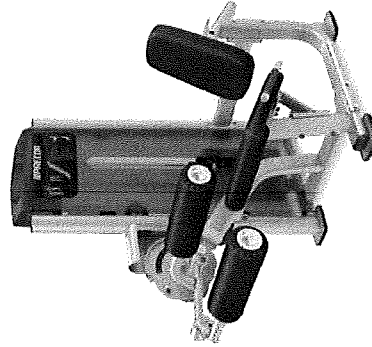

C007ES

Seated Leg Curl

- Dimensions (LxWxH): 157 x 109 x 145 cm (62 x 43 x 57 in)
- Weight: 205 kg (450 lbs)
- Weight stack: 78 kg (170 lbs)

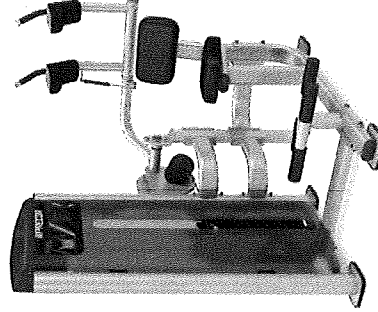

C014ES

Abdominal

- Dimensions (LxWxH): 147 x 99 x 145 cm (58 x 39 x 57 in)
- Weight: 210 kg (460 lbs)
- Weight stack: 91 kg (200 lbs)

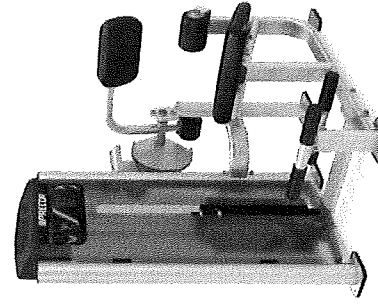

C011ES

Back Extension

- Dimensions (LxWxH): 135 x 99 x 145 cm (53 x 39 x 57 in)
- Weight: 205 kg (450 lbs)
- Weight stack: 91 kg (200 lbs)

*Also available with pulldown bar, as an optional extra.

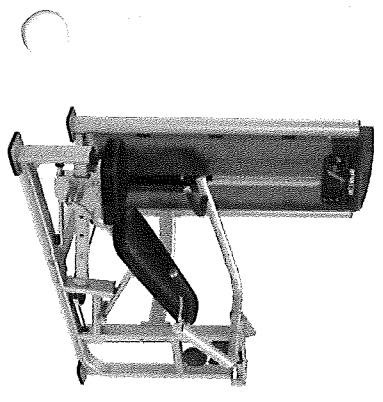

- CO24ES**
Multi Press
- Dimensions (LxWxH): 183 x 152 x 175 cm (72 x 60 x 69 in)
 - Weight: 205 kg (450 lbs)
 - Weight stack: 110 kg (240 lbs)

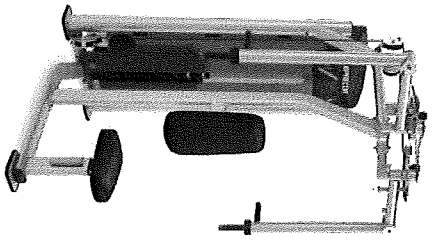

- CO15ES**
Rear Delt / Pec Fly
- Dimensions (LxWxH): 102 x 137 x 198 cm (40 x 54 x 78 in)
 - Weight: 214 kg (470 lbs)
 - Weight stack: 110 kg (240 lbs)

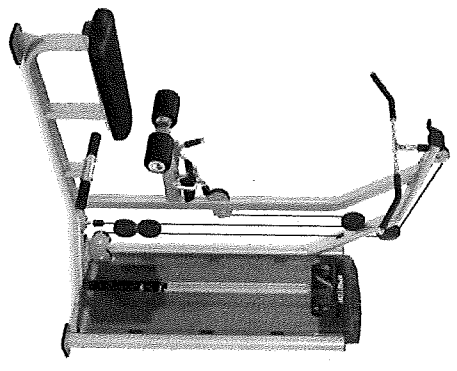

- CO26ES**
Pulldown / Seated Row
- Dimensions (LxWxH): 193 x 122 x 221 cm (76 x 48 x 87 in)
 - Weight: 222 kg (490 lbs)
 - Weight stack: 100 kg (220 lbs)

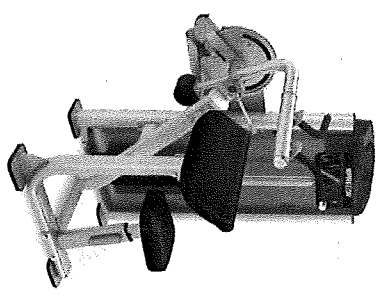

- CO25ES**
Biceps Curl / Triceps Extension
- Dimensions (LxWxH): 130 x 110 x 145 cm (51 x 43 x 57 in)
 - Weight: 180 kg (395 lbs)
 - Weight stack: 78 kg (170 lbs)

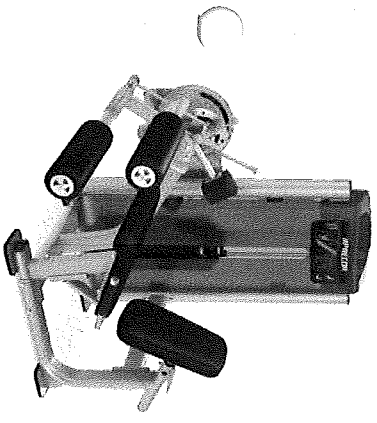

- CO27ES**
Leg Extension / Leg Curl
- Dimensions (LxWxH): 163 x 109 x 145 cm (64 x 43 x 57 in)
 - Weight: 240 kg (530 lbs)
 - Weight stack: 110 kg (240 lbs)

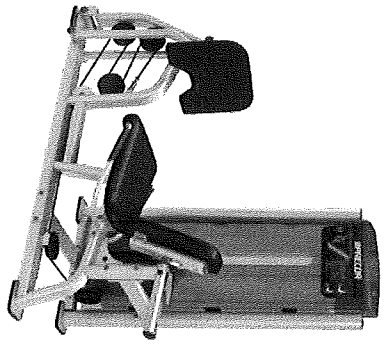

- CO10ES**
Leg Press / Calf Extension
- Dimensions (LxWxH): 193 x 109 x 175 cm (76 x 43 x 69 in)
 - Weight: 250 kg (550 lbs)
 - Weight stack: 135 kg (295 lbs)

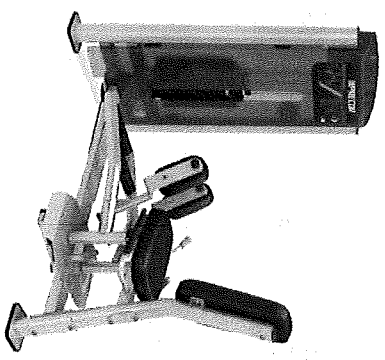

- CO08ES**
Inner / Outer Thigh
- Dimensions (LxWxH): 163 x 79 x 145 cm (64 x 31 x 57 in)
 - Weight: 200 kg (440 lbs)
 - Weight stack: 78 kg (170 lbs)

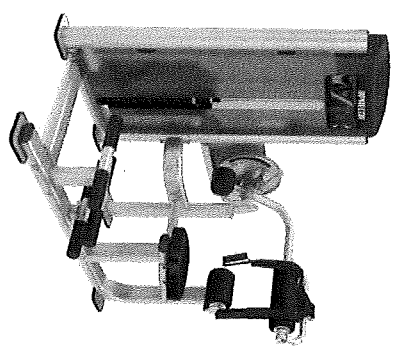

- CO28ES**
Abdominal / Back Extension
- Dimensions (LxWxH): 150 x 99 x 145 cm (59 x 39 x 57 in)
 - Weight: 210 kg (460 lbs)
 - Weight stack: 91 kg (200 lbs)

Vitality Series™

Designed for users of all levels, the Vitality Series is easy to use. These single and dual-station strength machines are intuitive, require minimal floor space and provide a comprehensive conditioning circuit that meets the budget requirements of a wide range of fitness facilities.

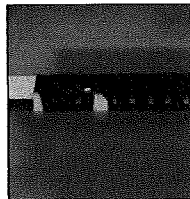

Add-on Weights - Each Vitality Series station features add-on weights. Users can easily engage the add-on weight with a simple push of a lever.

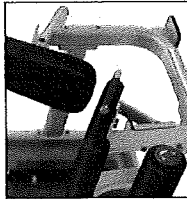

Compact - The Vitality Series is designed with limited space in mind. All machines have a small footprint and a low profile design.

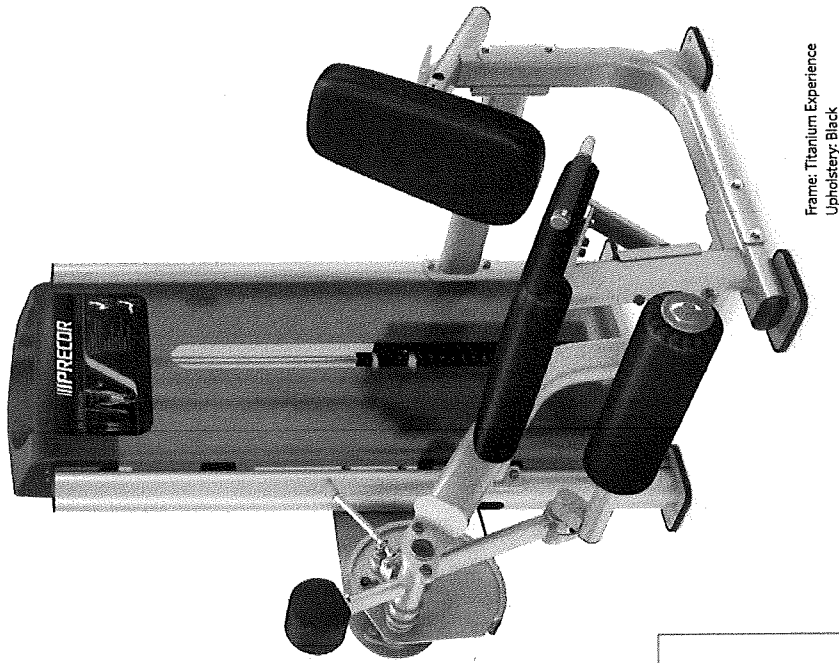

Frame: Titanium Experience
Upholstery: Black

Vitality Series Colors

Frame	Upholstery	Upholstery - optional	
Titanium Experience	Black (Standard)	Mahogany	Royal Blue
		Imperial Blue	American Beauty
		Paprika	Putty
		Graphite	Yew Green
		Dusty Jade	Terra Cotta

- Colors may vary.
- Upholstery colors other than black are available at an additional cost.
- Custom colors are available. Please contact a Precor sales representative.

PRECOR

Precor, Incorporated, 20031 142nd Avenue NE, P.O. Box 7202, Woodinville, WA 98072-4002.
Tel: +1 (0) 425-486-9292, Fax: +1 (0) 425-486-3856, E-mail: commiss@precor.com, www.precor.com

Precor reserves the right to make any changes without prior notice. Product photos are registered trademarks of Precor, Inc., registered in the U.S. and other countries.

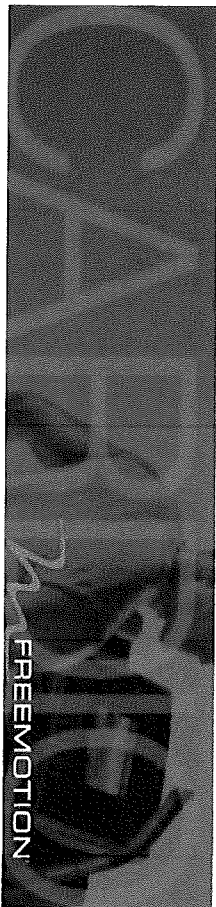

11.9 INCLINE TRAINER

DOMESTIC: FM17C4810

INTERNATIONAL: FM17K4810-INT

DOMESTIC TV: FM17V4810

INTERNATIONAL TV: FM17V4810-INT

FEATURES & BENEFITS

10" FULL-COLOR TOUCH SCREEN WITH BROWSER POWERED BY ANDROID™ • Browse the web* during any workout. With the built-in 10" full-color touch screen and browser powered by Android™, every FreeMotion® Cardio machine delivers the ultimate motivation to your gym members. Now, they can check the news, read email, watch sports highlights, get on Facebook® and more! Plus, with wireless connectivity and a USB connection, console software is upgradeable for the life of the product.

IFT LIVE™ TECHNOLOGY BUILT-IN • Get smarter workouts and faster results with IFT Live™ Technology. Featuring workouts powered by Google Maps™, training with Jillian Michaels and personalized, goal-specific programs, this wireless technology is the ultimate workout experience! Speed, incline and decline controls automatically adjust to match terrain and maximize results. Now, users can customize their own fitness program, receive automatic workout downloads and manage their profile online.

INCLINE AND DECLINE TRAINING • With up to 30% incline, users will recruit more muscle on the 11.9, targeting their quads and glutes, and to perfect cadence and strengthen their legs for the downhill segments of the next marathon or 10K, the 3% decline adds variety and realistic training to any program. The lift motor, specifically designed for the Incline Trainer, delivers 1500 lbs. of lift force for consistent deck movement and stabilization.

17" FREEMOTION™ HDTV – OPTIONAL UPGRADE • Add motivation to any workout with this optional upgrade. A wide viewing angle and dynamic contrast and color saturation combine for a beautiful picture. Individual product TVs deliver a more personalized, entertaining workout for every user. The FreeMotion® Cardio consoles feature integrated TV controls and are pre-wired for a fast and easy upgrade.

DIRECT REAR VELOCITY SYSTEM • This self-cooling, 5.0 CHP high-torque, brushless AC speed control motor is positioned at the back of the machine for a smoother running surface and easier maintenance.

INCLINE AND DECLINE TRAINING • With up to 30% incline, users will recruit more muscle on the 11.9, targeting their quads and glutes. And, to perfect cadence and strengthen their legs for the downhill segments of the next marathon or 10K, the 3% decline adds variety and realistic training to any program. The lift motor, specifically designed for the Incline Trainer, delivers 1500 lbs. of lift force for consistent deck movement and stabilization.

9 BUILT-IN WORKOUTS • Pre-set workouts deliver competition, weight-loss, men and HD video workouts to help users of all levels reach their goals. Quick console controls make it easy to get started!

EXTRA-LONG, CUSHIONED DECK • Featuring a commercial, double-layered, double-sided deck, the 11.9 Incline Trainer is built to last. Users can stretch out their stride with the 22" x 60" 2-ply, maintenance-free treadmill and feel the incredible joint protection with built-in bolster cushioning.

QUICK WORKOUT CONTROLS • Quickly adjust speed, incline and decline with these convenient console controls. Members can personalize their workout with the touch of a button instead of scrolling through settings found on other equipment.

BUILT-IN WIRELESS CONTROLS • Connect each machine wirelessly to Cardio Theater, BroadCastVision™ Entertainment, MYETV™ Entertainment, CardioVision and Fantasy™ audio, broadcasting, built-in compatibility eliminates the need for other hardware or wires.

ENTERTAINMENT CHARGING STATION • Charge an iPod™, MP3 Player or phone during any workout with this convenient charging station. A headphone jack allows the user to listen to their music and Jillian Michaels during an IFT Live™ Workout.

*Web browsing feature can be disabled.

†iPod is a trademark of Apple, Inc., registered in the US and other countries. Product name included.

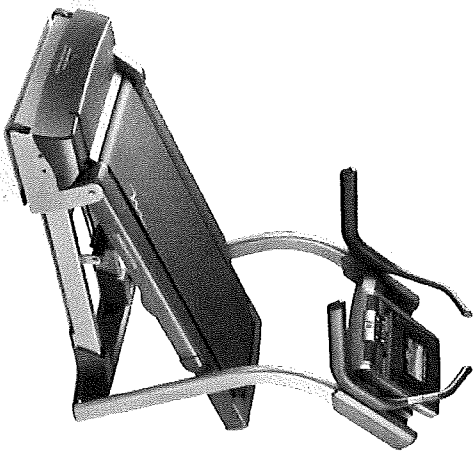

PRODUCT SPECIFICATIONS

New Workout Features	IFT Live™ Technology, Built-in, 10" Touch Screen with Browser Powered by Android™
Dimensions (LxW)	78" x 33" (198 cm x 84 cm)
Weight Capacity	400 lbs. (181 kgs)
Warranty	Lifetime Motor & Frame, 3-Year Parts (including belt and deck wear) & Labor, 1-Year Touch Screen & TV
Built-in/Wireless Controls	Cardio Theater, BroadCastVision™ Entertainment, MYETV™ Entertainment, CardioVision, Fantasy™, FreeMotion™ HDTV

OTHER FEATURES

- 0 – 12 MPH 1-Step™ Speed Control
- 0 – 30% 1-Step™ Incline Control
- -3 – 0% 1-Step™ Decline Control
- Set-4-Goal Workout Center
- (2) 4" AudioBreeze™ Workout Fans
- 3.5" Curved, Spin-Balanced Rollers
- Dual-Grip Heart Rate Monitor
- Compatible with Polar® Wireless Chest Strap™
- 17" FreeVision™ HDTV – Optional Upgrade

FREEMOTION® CARBIO 11.9 INCLINE TRAINER

FREEMOTION® CARBIO 11.9 INCLINE TRAINER

877.353.8449 | www.freemotionfitness.com



TRM[®] 731 Treadmill

The TRM[®] 731 combines essential reliability and ease-of-use with an intuitive console at a value just right for you. This treadmill is designed to optimize performance and maintenance while providing a comfortable and effective workout for your exercisers. The simple, clean design holds up under heavy commercial use, ensuring your investment will last into the future.

The 730 Line console complements the line through form and function, with easy-to-use motion controls, a LED display with essential workout stats to keep exercisers moving, and a mobile device charger.

At Precor, we recognize that a great workout is the sum of many parts. In your hands, the products, services and technologies we offer can be combined in countless ways to complement the programs and atmosphere you're creating.



Learn more at [precor.com/trm731](https://www.precor.com/trm731)

PRECOR
Fitness Made Personal

©2016 Precor Incorporated

TRM[®] 731 Treadmill

Product Features

- 1. Console** - The 730 Line console features easy-to-use motion controls and an LED display that focuses on the essential fitness stats that keep users informed and engaged. Add an optional Entertainment Cap to provide access to a selection of audio channels, including those from wall or ceiling-mounted displays, or a Personal Viewing System (PVS) to give exercisers a more personal entertainment experience, with total choice and control.
- 2. Motor Drive System** - The motor drive system improves performance, efficiency, and reliability through improved internal cooling, a wider operating range, and unique input current averaging to identify more precisely when a running belt requires replacement.
- 3. Integrated Footplant Technology™** - Recognizes exercisers natural foot speeds and matches every stride for an ultra-smooth feel that enhances their workout experience.
- 4. Ground Effects® Impact Control System** - Our patented system combines ideal cushioning, support, and stability for exercisers. Precor decks are designed to provide more absorption in the front where exercisers feet hit the belt and added rigidity at the back for a firm push-off.
- 5. Active Status Light™** - To increase up-time an external status light lets you and your staff know at a glance the operating condition of your treadmill and when to perform life-extending maintenance.



SPECIFICATIONS

Dimensions (L x W x H): 83 x 35 x 62 inches / 211 x 89 x 157.5 cm

Equipment weight: 405 lbs / 184 kg

Step-up Height: 9.5 in / 24 cm

Handrail Length: 24 in / 46 cm

Running Surface: 60 x 22 in / 153 x 56 cm

Speed Range: 0.5 - 12 mph / 0.8 - 19.2 km/h

Decline/incline Range: 0% to 15% incline in 0.5% increments

Power: Dedicated 120 volt, 20 amp circuit

Total Workouts: 27

Language Selection: English, French, German, Spanish, Dutch, Italian, Russian, Portuguese, Japanese, Chinese

Network Capabilities: C-SAFE enabled
Mobile Device Charger - Standard

Entertainment: Optional - 15" Personal Viewing System (PVS)
Optional - Wireless entertainment cap

Accessories: Integrated reading rack
Optional - Cable management

Warranty: Visit www.precor.com for warranty terms

Learn more at precor.com/trm731

PRECOR
Fitness Made Personal



EXPERIENCE SERIES™
810 Line



BASIC ESSENTIALS

The 810 Line provides all the essential features with a premium feel.

AMT® 813

Adaptive Motion Trainer™

Like every piece of equipment in our Experience Series™ 810 Line, the AMT® 813 combines essential reliability and ease-of-use with a natural, low-impact stride to add value to your facility. The 810 Line is our most affordable and whether on its own or alongside the rest of the Experience Series™ cardio equipment, the 810 Line offers the essential features with a premium feel.

At Precor, we recognize that a great workout is the sum of many parts. In your hands, the products, services and technologies we offer can be combined in countless ways to complement the programs, and atmosphere you're creating.

PRECOR®

AMT 813

Adaptive Motion Trainer

EXPERIENCE SERIES™
810 Line

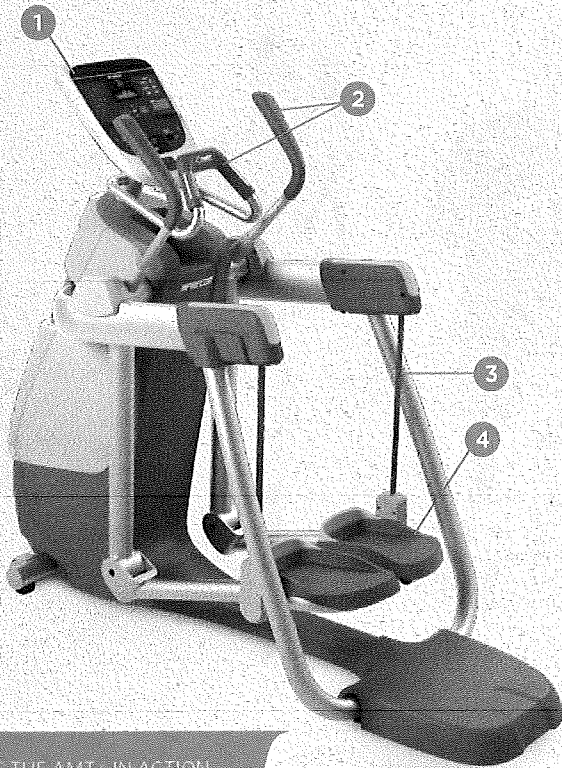

The innovative and premium design of the Adaptive Motion Trainer® (AMT®) 813 now has a longer stride length to provide exercisers of all fitness levels with a wider range of motions during workouts. The AMT 813 intuitively responds to users' natural motion, allowing them to adapt their stride length for a comprehensive cardio workout - all without so much as the push of a button.

PRODUCT HIGHLIGHTS

- 1 Console**
Created to complement the entire Experience Series™ line, the P10 console features easy to use motion controls and a LED-based console that focuses on the essential fitness stats that keep users moving.
- 2 Handlebars Fit Everyone**
Three distinct positions on the moving handlebars provide a comfortable fit for nearly every user. The Rodeo grip has a heart rate sensor built-in that provides monitoring and a stable, comfortable position when focusing on the lower body.
- 3 Total Body Workout in One Piece of Equipment**
Users can go from short stride to long stride, walking to running, stepping to climbing, allowing them to target different muscle groups. Pushing and pulling the moving handlebars will engage the upper body, resulting in a total body workout.
- 4 Adaptive Motion**
Naturally adapt stride length - without the need to push a button - from zero to 36 in (91 cm), to match the desired workout for each unique user.

SEE THE AMT® IN ACTION
AMTFITNESS.COM



Optional wireless entertainment cap

P10 Console

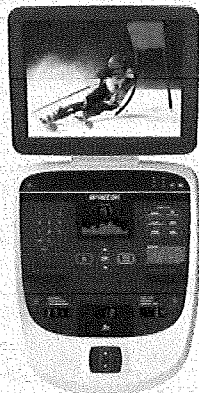

P10 Console with optional 15" Personal Viewing System

PRODUCT SPECIFICATIONS

Dimensions (L x W x H): 80 x 35 x 69 in / 203 x 89 x 175 cm
Product Height with PVS: 81 in / 208 cm
Weight: 412 lbs / 187 kg
Power: Self-powered

Total Workouts: 6
Resistance Levels: 1 - 20
Adjustable Stride Length: 0 - 36 in / 0 - 91 cm
Language Selection: English, Dutch, French, German, Italian, Portuguese, Romanized Russian, and Spanish

Entertainment: Optional - 15" Personal Viewing System (PVS)
Optional - Wireless entertainment cap
Optional - Personal Entertainment Player (PEP)

Accessories: Accessories holder
Reading rack
Optional - Cable management

Warranty: Frame - 7 years
Parts (Mechanical & Electronic) - 2 years
Wear Items - 1 year
Labor - 1 year

PRECOR®

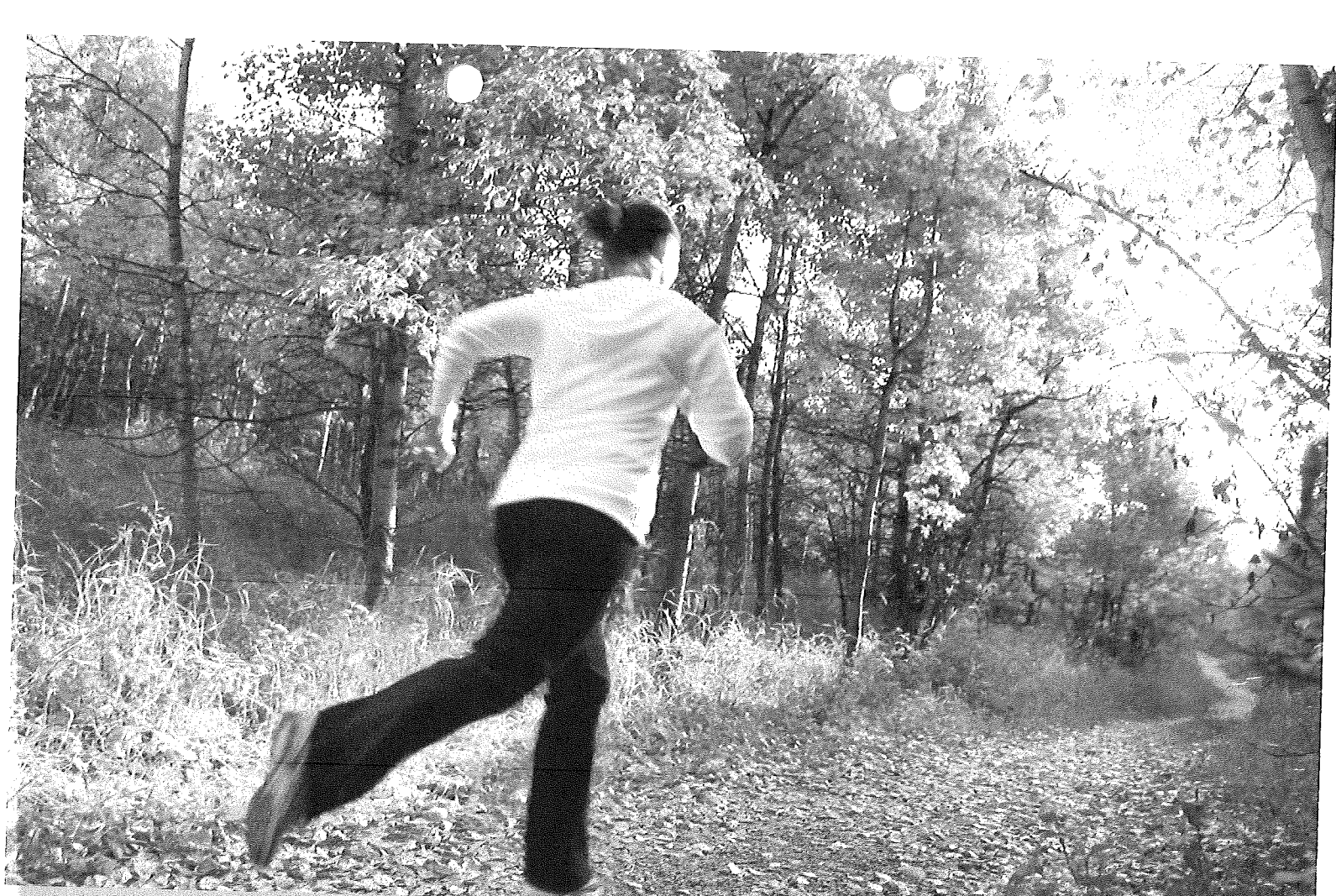

EXPERIENCE™ SERIES
810 Line

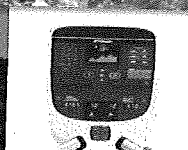
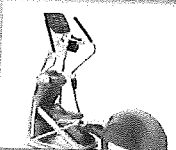

BASIC ESSENTIALS

The 810 Line provides all the essential features with a premium feel.

EFX[®] 815

Elliptical Fitness Crosstrainer™

Like every piece of equipment in our Experience Series 810 Line, the EFX[®] 815 combines essential reliability and ease-of-use with a natural, low-impact stride to add value to your facility. The 810 Line is our most affordable and whether on its own or alongside the rest of the Experience Series cardio equipment, the 810 Line offers the essential features with a premium feel.

At Precor, we recognize that a great workout is the sum of many parts. In your hands, the products, services and technologies we offer can be combined in countless ways to complement the programs, and atmosphere you're creating.

PRECOR[®]

EFX 815

Elliptical Fitness Crosstrainer™

EXPERIENCE™ SERIES
810 Line



The EFX® 815 combines the benefits of CrossRamp® technology and upper body moving handlebars for a total-body workout. CrossRamp technology, unique to Precor, offers ramp inclines from 13 to 40 degrees, which allows users to target different muscle groups.

PRODUCT HIGHLIGHTS

- 1 **Moving Handlebars**
Moving handlebars for a total-body workout.
- 2 **Console**
Created to complement the entire Experience Series™ line, the P10 console features an LED-based console that focuses on the essential fitness stats that keep users moving.
- 3 **CrossRamp® Technology**
Users can isolate or crosstrain specific lower body muscle groups simply by adjusting the angle of the ramp, making it easy for users to focus on their individual fitness goals.
- 4 **Biomechanics**
Our patented elliptical path perfectly mimics a natural running stride, allowing users to keep their heels down for a more comfortable, effective and ergonomically correct motion.

PRODUCT SPECIFICATIONS

Dimensions (L x W x H): 80 x 32 x 68 in / 203 x 81 x 173 cm
 Product Height with PVS: 84 in / 213 cm
 Weight: 338 lbs / 153 kg
 Power: Self-powered

Total Workouts: 6
 Resistance Levels: 20
 CrossRamp® Range: 13-40°
 Language Selection: English, Dutch, French, German, Italian, Portuguese, Romanized Russian, and Spanish

Entertainment: Optional - 15" Personal Viewing System (PVS)
 Optional - Wireless entertainment cap

Accessories: Accessories holder
 Reading rack
 Optional - Cable management

Warranty: Frame - 7 years
 Parts (Mechanical & Electronic) - 2 years
 Labor - 1 year

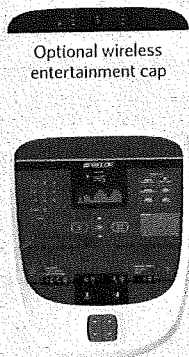

Optional wireless entertainment cap

P10 Console



P10 Console with optional 15" Personal Viewing System



REX™ Recumbent Elliptical Product Specifications

Order Code: REX7001-INT

FEATURES

Total body movement	Smooth, elliptical motion for efficient total body exercise in both directions
Optimized torso rotation	Knee-to-elbow motion provides core muscle recruitment
Smooth, natural knee movement	Replicates climbing stairs to help improve functional gait
Dependent movement	Allows individuals to use strong limbs to drive weaker limbs through the range of motion
Oversized foot beds	With safety edge for comfort and stability
Foot Straps	Large foot straps help keep feet securely in place
Dual position handles	Provide multiple hand positions and allow muscle change on the fly
Premium seat	Seat adjusts forward/back and swivels for easy entry
Easy to transport	Integrated transport wheels
Heart rate monitoring	Telemetric (chest strap required)

Movement and Resistance

Bi-directional movement and resistance	Exercising in forward and reverse provides versatility, helps prolong exercise and promotes reciprocal muscle balance
Variable starting resistance	6 watts
Resistance range	191 levels of resistance - 20 levels adjustable in .1 increments
Resistance system	3 phase combination generator & eddy current brake - largest watt range in the industry

Intelli-FIT™ CONSOLE

Full color touch screen display	Touch screen with clear, simple screens and large, readable font.
Beep	Yes
Buttons	Tactile buttons in addition to touch screen
Resistance levels	191 levels of resistance - 20 levels adjustable in .1 increments
Feedback	Time, level, distance, METs, heart rate, calories, RPM, watts
Quick start	Yes
Constant Work Program	Set constant METs level and the workload remains constant throughout the program.
Program	Isokinetic program for safe, accommodating resistance
Mode	8-second burst of high intensity training
Console languages	Automatic cool down begins after each exercise is completed
USB to USB flash drive	User defined settings, metric or US units of measure and other custom settings
12-volt DC power port	9 languages - English, Spanish, French, German, Russian, Japanese, Chinese, Italian, Dutch
	Plug USB flash drive into the Fit-Key® slot to save workout results in a .txt file
	Yes
	For phones and other electronic devices

data

heavy-duty

Intelli-Fit, Bio-Flex and Patent Pending in the

1/11/11

C

C

1/11/11



Advantages of Working with Direct Fitness Solutions

Made in the USA Quality

Unlike the Matrix and Octane equipment specified, Precor treadmills, elliptical machines, and Adaptive Motion Trainers (AMT) are made in the USA (Woodinville, Washington). The quality and attention to detail set Precor apart from its competitors and provide its customers with the best fitness experience possible. In addition, SciFit is manufactured in Tulsa Oklahoma, and the Free Motion Incline Trainer is manufactured in Logan, Utah.

Treadmill Motor Rating

One factor often overlooked when evaluating is the quality and ratings of the treadmill motors. Horsepower isn't necessarily the main indicator of motor quality. The industry standard for heavy commercial treadmills is 4.0hp. While a 5.0hp motor may seem "more durable" on the surface, it doesn't actually do anything more than a 4.0hp motor. It just uses more energy (and creates more heat) to perform the same function.

In addition, treadmill motors are rated by how well insulated they are from the heat that builds up during usage. The insulation classes are A (105 degrees), B (130 degrees), F (155 degrees), and H (180 degrees). B and F are the most common classes used by fitness companies for industrial-duty motors. The Matrix T5x has an A rating while the Precor TRM731 proposed has an F rating for their motors.

Versatility

Precor invented the elliptical in the 90's and has been the industry leader since then. Ten years ago, Precor took the elliptical concept a step further and invented the AMT. Both of these units provide their users with more variety. The EFX815 elliptical has a patented adjustable cross ramp that allows the users to change the muscles they use during the workout. Other elliptical machines don't offer this same feature for its users.

When using most elliptical type machines, the user has a set stride pattern. However, with the AMT, the user can change their stride pattern while on the machine. The user can choose a stride pattern that best fits their body instead of having to adapt their body to the machine.



Faint, illegible text at the top of the page, possibly a header or introductory paragraph.

Second block of faint, illegible text in the middle of the page.

Third block of faint, illegible text at the bottom of the page.

